

## PERNIO TORNEADO

Ref. PH1 (Grupo 1)



Medidas	Embalaje
8 x 50	100
10 x 60	60
10 x 70	60
12 x 60	40
12 x 70	40
12 x 80	40
12 x 90	40
12 x 100	40
14 x 80	27
14 x 90	27
14 x 100	27
16 x 90	24
16 x 100	24
16 x 120	24
18 x 100	24
18 x 110	21
18 x 120	21
20 x 100	21
20 x 120	18
20 x 130	15
20 x 140	15
22 x 120	12
22 x 130	10
22 x 140	10
25 x 120	10
25 x 140	8
25 x 150	8
30 x 150	6

## PERNIO TORNEADO CON RODAMIENTO AXIAL

Ref. PH1 (Grupo 2)



Medidas	Embalaje
16 x 100	24
18 x 120	21
20 x 120	18
25 x 120	10
25 x 150	8
26 x 150	8
30 x 150	6
35 x 150	6
35 x 200	12
42 x 150	4
55 x 150	2

## PERNIO TORNEADO CON REMATE Y RODAMIENTO

Ref. PH1 (Grupo 3)



Medidas	Embalaje
20 x 150	10
25 x 180	6

## PERNIO AVELLE REGULABLE

Ref. PH4 (Grupo 2)



Medidas	Embalaje
25 x 120 izda.	12
25 x 120 dcha.	12

## PERNIO TORNEADO PERFIL GOTA

Ref. PGH9 (Grupo 1)



Medidas	Embalaje
10 x 60	60
14 x 80	28
14 x 100	24
16 x 100	35
16 x 120	30
20 x 120	18
20 x 150	15
23 x 150	12
23 x 180	10

## PERNIO PERFIL GOTA CON RODAMIENTO AXIAL

Ref. PGH10 (Grupo 2)



Medidas	Embalaje
14 x 80	28
16 x 100	35
20 x 120	18
23 x 150	12

## PERNIO 3 CUERPOS

Ref. PH13 (Grupo 4)



Medidas	Embalaje
16 x 100	30
20 x 120	20
25 x 150	12

## PERNIO PALA

Ref. PP1 (Grupo 2)



Medidas	Embalaje
25 x 60 x 2	100
12 x 80 x 2	80
14 x 80 x 3	50
16 x 100 x 3	50
18 x 110 x 4	40
20 x 120 x 5	30
25 x 120 x 5	24
30 x 150 x 6	24

### PERNIO TORNEADO ACERO INOXIDABLE AISI 303

Ref. PH5 (Grupo 3)



Medidas	Embalaje
8 x 50	100
10 x 60	60
12 x 70	40
14 x 80	27
16 x 100	24
18 x 110	21
20 x 120	18
25 x 150	8

### AISI 316

Ref. PH6 (Grupo 3)

Medidas	Embalaje
12 x 70	40
16 x 100	24
20 x 120	18
25 x 150	8

### PERNIO CON RODAMIENTO AXIAL

ACERO INOXIDABLE AISI 303

Ref. PH7 (Grupo 3)



Medidas	Embalaje
20 x 120	18
25 x 150	8

### AISI 316

Ref. PH8 (Grupo 3)

Medidas	Embalaje
20 x 120	18
25 x 150	8

### PERNIO PERFIL GOTA ACERO INOXIDABLE AISI 316

Ref. PGH11 (Grupo 3)

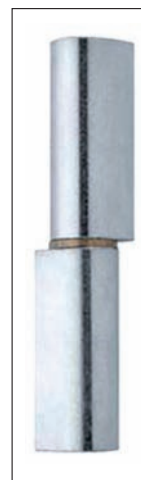

Medidas	Embalaje
16 x 100	15
20 x 120	10
20 x 150	8

### PERNIO PALA TAPÓN CON RODAMIENTO AXIAL

Ref. PP2 (Grupo 2)



Medidas	Embalaje
20 x 120 x 5 izda.	30
20 x 120 x 5 dcha.	30
25 x 150 x 5 izda.	8
25 x 150 x 5 dcha.	8

### PERNIO PALA TAPÓN ACERO INOXIDABLE AISI 304

Ref. PP3 (Grupo 2)



Medidas	Embalaje
12 x 80 x 2 izda.	18
12 x 80 x 2 dcha.	18
18 x 100 x 3 izda.	12
18 x 100 x 3 dcha.	12
20 x 140 x 3 izda.	6
20 x 140 x 3 dcha.	6

### PERNIO PALA TAPÓN CON RODAMIENTO AXIAL

ACERO INOXIDABLE AISI 304

Ref. PP4 (Grupo 2)



Medidas	Embalaje
18 x 110 x 3 izda.	12
18 x 110 x 3 dcha.	12
20 x 150 x 3 izda.	6
20 x 150 x 3 dcha.	6

### PERNIO PERFIL GOTA CON RODAMIENTO AXIAL

ACERO INOXIDABLE AISI 316

Ref. PGH12 (Grupo 3)



Medidas	Embalaje
16 x 100	15
20 x 120	10
20 x 150	8

### PERNIO TORNEADO ESPECIAL

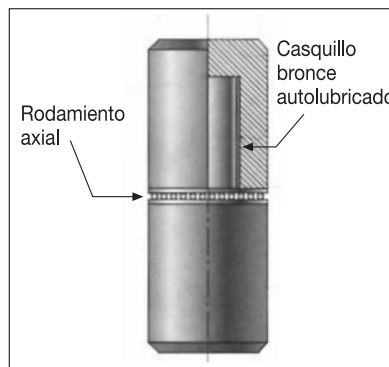

PT F:111

Ø	L
24	110
30	130
42	130

## Perfiles y accesorios

Guía corredera abierta para empotrar

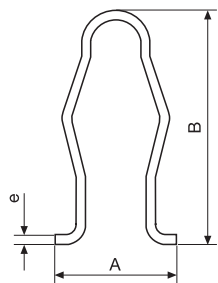
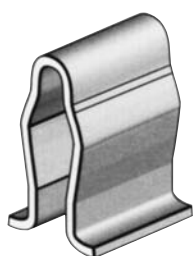

MEDIDAS		ESPESOR	ACABADO	LONGITUD BARRAS
A	x B			
44	64	3	Galvanizado	6 metros

Guía corredera para atornillar

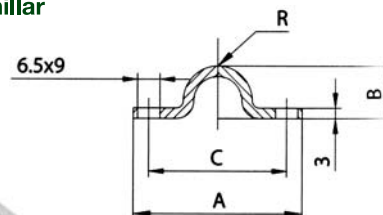

MEDIDAS		ESPESOR	ACABADO	LONGITUD BARRAS
A	x B			
60	15	3	Galvanizado	6 metros

Guía corredera "KLEIN"

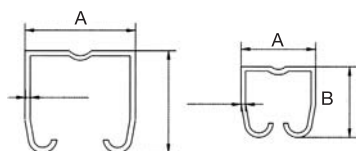
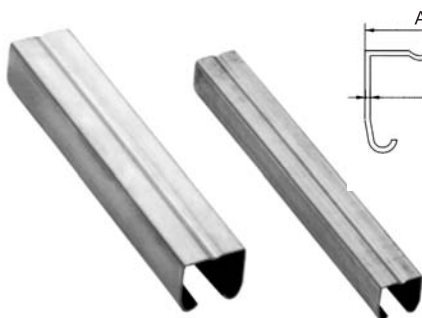

MEDIDAS		ESPESOR	ACABADO	LONGITUD BARRAS
A	x B			
30	x 33	1,5	Galvanizado	6 metros
40	x 40	1,5	Galvanizado	6 metros
60	x 55	2,5	Galvanizado	6 metros
60	x 63	2,5	Galvanizado	6 metros

Curva para rodillos Ubao

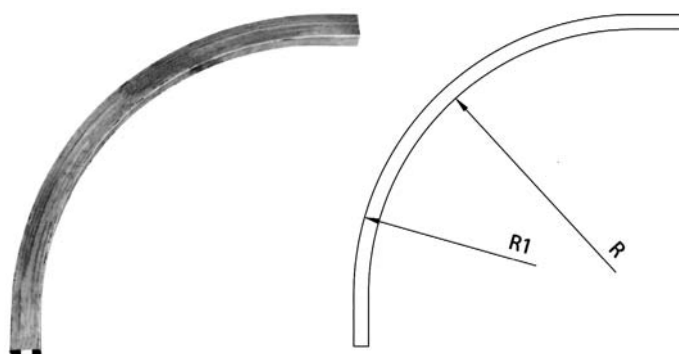

MEDIDAS	R	R1
Curva U-40	78	82
Curva U-60	70	76

Rodillos Ubao



**RODILLO DOBLE**  
Rodillo R-2 Fuerte  
Rodillo A.R.2 Sencillo  
Acabado: bicromatado

**RODILLO SIMPLE**  
Rodillo R-1 Fuerte  
Rodillo A.R.1 Sencillo  
Acabado: bicromatado

Tiradores

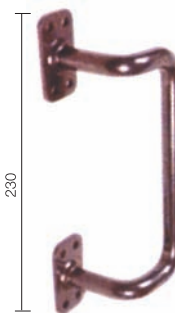

LISO

ESCUADRA

EMBUTIBLE



250 Kgs.  
A.1 (Abrazadera)

100 Kgs.  
A.A.1 (Abrazadera)

**Tope para puerta cancela dos hojas**



**Tapa cuadrada superior**

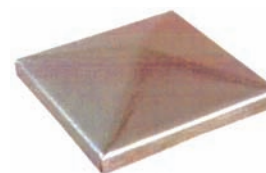

Material: CHAPA

30, 40, 50, 60, 80, 100, 120, 150

**Polea canal cuadrada 10 mm**

Cód.	Medidas
965	60x10
966	70x10
967	80x10
968	90x10
969	100x10
970	120x10

**Polea doble canal**

Cód.	Medidas
142	100x29
113	120x29
114	150x29
118	180x29
115	200x29

**Polea canal cuadrada 20 mm**

Cód.	Medidas
973	80x20
974	90x20
975	100x20
976	120x20
977	150x20

**Polea canal 10 mm**

Cód.	Medidas
100	45x10
101	60x10
102	70x10
103	80x10
104	90x10
105	100x10
106	120x10
111	150x10
116	180x10
112	200x10
143	250x10

**Polea nylon canal 10 mm**

Cód.	Medidas
360	45x10
361	60x10
362	70x10
363	80x10
364	90x10
365	100x10
366	120x10
367	150x10
381	180x10
368	200x10

**Polea chapa canal 10 mm**

Cód.	Medidas
515	100x10
516	120x10
517	160x10
518	220x10

**Chapa hexagonal**

Cód.	Medidas
150	Hex. 27 mm.
151	Hex. 32 mm.

**Rodillo guía**

UPN

Cód.	Medidas
1351	U-40
135	U-50
136	U-60 M. 12
141	U-60 M. 16
137	U-70
138	U-80
139	U-90
140	U-100
<b>UPN</b>	
393	UPN-80
394	UPN-100

**Bisagra ángulo superior**

Cód.	Medidas
162	40x40
163	32x32

**Bisagra ángulo superior con chapa**

Cód.	Medidas
164	160x40x8 Izda./Dcha.
160	175x50x10 Izda./Dcha.

**Freno de seguridad**

Cód.	Medidas
450	U-40
452	U-50
454	U-60
455	U-80
4571	U-100
<b>UPN</b>	
456	OPN 80
457	UPN 100

## Polea canal 20 mm "U"



Cód.	Medidas
447	70x20
124	80x20
107	90x20
123	100x20
108	120x20
109	150x20
355	160x20
117	180x20
110	200x20

### Acero inoxidable AISI 303

395	80x20
396	100x20
397	120x20

## Polea canal 20 mm "V"



Cód.	Medidas
446	70 V
379	80 V
125	90 V
128	100 V
126	12 V
127	150 V
3562	200 V

### Acero inoxidable AISI 303

144	80 V
398	100 V
399	120 V

## Polea doble rodamiento



Cód.	Medidas
356	200x20
120	250x20
121	300x20
122	320x20

## Polea canal 16 mm "U"



Cód.	Medidas
146	80x16
425	90x16
426	100x16
427	120x16
428	150x16

## Polea canal 20 mm "U" con caja



Cód.	Medidas
300	80x20
301	90x20
302	100x20
303	120x20
304	150x20
305	200x20

### Acero inoxidable AISI 304

672	80x20
673	100x20
674	120x20

## Polea canal 20 mm "V" con caja



Cód.	Medidas
445	80 V
307	90 V
308	100 V
309	120 V
310	150 V

### Acero inoxidable AISI 304

675	80 V
676	100 V
677	120 V

## Polea canal 16 mm "U" con caja



Cód.	Medidas
421	80x16
429	90x16
430	100x16
431	120x16
432	150x16

## Polea canal 20 mm "U" para encastrar



Cód.	Medidas
159	80x20
168	90x20
169	100x20
170	120x20

### Acero inoxidable AISI 303 - 304

678	80x20
679	100x20
680	120x20

## Polea canal 20 mm "V" para encastrar



Cód.	Medidas
152	80 V
172	90 V
173	100 V
174	120 V

### Acero inoxidable AISI 303 - 304

681	80 V
682	100 V
683	120 V

**Polea canal 16 mm "U" para encastrar**

Cód.	Medidas
422	80x16
433	90x16
434	100x16
435	120x16

**Polea canal 16 mm "U" con soporte**

Cód.	Medidas
423	80x16
436	90x16
437	100x16
438	120x16

**Polea canal 20 mm "V" con soporte**

Cód.	Medidas
420	80 V
442	90 V
443	100 V
444	120 V

**Polea canal 20 mm "U" con soporte**

Cód.	Medidas
419	80x20
439	90x20
440	100x20
441	120x20

**Acero inoxidable AISI 303 - 304**

684	80x20
685	100x20
686	120x20

**Polea nylon canal 20 mm "U" con caja**

Cód.	Medidas
312	80x20
313	90x20
314	100x20
315	120x20
316	150x20
317	200x20

**Acero inoxidable AISI 303 - 304**

741	80x20
743	100x20
744	120x20

**Acero inoxidable AISI 303 - 304**

687	80 V
688	100 V
689	120 V

**Polea nylon canal 20 mm "V" con caja**

Cód.	Medidas
311	80 V
318	90 V
319	100 V
320	120 V
321	150 V

**Acero inoxidable AISI 303 - 304**

747	80 V
749	100 V
750	120 V

**Polea nylon canal 20 mm "U"**

Cód.	Medidas
369	80x20
370	90x20
371	100x20
372	120x20
373	150x20
3811	180x20
374	200x20

**Acero inoxidable AISI 303**

730	80x20
731	90x20
732	100x20
733	120x20
734	150x20
735	200x20

**Polea nylon canal 20 mm "V"**

Cód.	Medidas
380	80 V
375	90 V
376	100 V
377	120 V
378	150 V

**Acero inoxidable AISI 303 - 304**

736	80 V
737	90 V
738	100 V
739	120 V
740	150 V

**Polea nylon canal 20 mm "U" para encastrar**

Cód.	Medidas
218	80x20
212	90x20
213	100x20
214	120x20

**Acero inoxidable AISI 303 - 304**

752	80x20
753	90x20
754	100x20
755	120x20

## Polea nylon canal 20 mm "V" para encastrar



Cód.	Medidas
219	80 V
215	90 V
216	100 V
217	120 V

### Acero inoxidable AISI 303 - 304

756	80 V
757	90 V
758	100 V
759	120 V

## Polea nylon canal 20 mm "U" con soporte



Cód.	Medidas
354	80x20
382	90x20
383	100x20
384	120x20

### Acero inoxidable AISI 303 - 304

760	80x20
761	90x20
762	100x20
763	120x20

## Polea nylon canal 20 mm "V" con soporte



Cód.	Medidas
353	80 V
385	90 V
386	100 V
387	120 V

### Acero inoxidable AISI 303 - 304

764	80 V
765	90 V
766	100 V
767	120 V

## Polea Caja Ø60



Cód.	Medidas	Acabado
36016	60x16	Aluminio
36016/1	60x16	Blanco
36016/2	60x16	Negro

### Acero inoxidable AISI 303

36016PI	60x16	Aluminio
36016/1PI	60x16	Blanco
36016/2PI	60x16	Negro

## Polea semi-encastrar Ø60



Cód.	Medidas	Acabado
26016	60x16	Aluminio
26016/1	60x16	Blanco
26016/2	60x16	Negro

### Acero inoxidable AISI 303

26016PI	60x16	Aluminio
26016/1PI	60x16	Blanco
26016/2PI	60x16	Negro

## Polea Caja Ø60



Cód.	Medidas	Acabado
16016	60x16	Aluminio
16016/1	60x16	Blanco
16016/2	60x16	Negro

### Acero inoxidable AISI 303

16016PI	60x16	Aluminio
16016/1PI	60x16	Blanco
16016/2PI	60x16	Negro

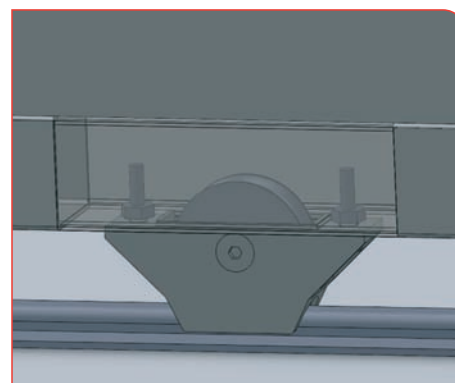
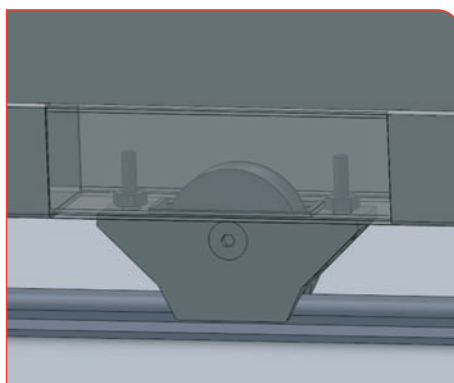
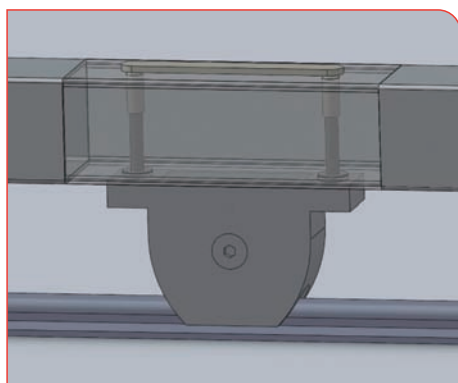

**Tirador**

Cód.	Medidas
576	175x76 - Mediano
577	200x90 - Grande

**Tope**

Cód.	Medidas
5792	50x85 - Pequeño
5802	70x130 - Grande

**Tope atornillar**

Cód.	Medidas
5803	70x130 - Atornillar

**Polea pivotante canal 16 mm "U"**

Cód.	Medidas
147	120x16

**Cerradura de gancho**

Cód.	Medidas
325	Cil. 55 mm. lat. centrado
3250	Sin cilindro
424	Cil. 55 mm. lat. centrado
4240	Sin cilindro

**Caja para cerradura**

Cód.	Medidas
326	40 mm.
327	50 mm.

**Caja poleas guía regulable**

Cód.	Medidas
167	Mediana
1675	Mediana Simple de 35 mm
171	Grande

**Acero inoxidable AISI 303-304**

358	Mediana
359	Grande

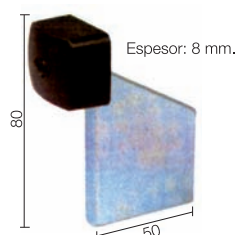
**Tope para puertas correderas****Carril empotrar mariposa "U" 20 mm**

Cód.	Medidas
700	25x35
133	30x30
132	35x35
134	40x40
1342	40x40
701	10x60

**Acero inoxidable AISI 303**

51332	30x30
1321	35x35
1341	40x40

**Caja poleas guía simple**

Cód.	Medidas
161	Simple
1614	Simple Simple de 35 mm

**Acero inoxidable AISI 303-304**

306	Simple
-----	--------

**Polea guía de hierro**

Cód.	Medidas
130	42 mm U-50
131	52 mm U-60
1311	72 mm U-80

## Bisagra regulable con dado



Cód.	Medidas
565	M 20

## Placa para bisagra regulable



Cód.	Medidas
569	M 20

## Tope puerta



Cód. 584

Cód. 585

Cód. 578

Cód.	Medidas
578	Redondo
584	Atornillar
585	Encarcelar

## Punto de giro 70 mm con rodamiento



Cód.	Medidas
166	70 mm Juego
1661	70 mm Superior
1662	70 mm Inferior

## Punto de giro 42 mm con rodamiento



Cód.	Medidas
175	42 mm Juego
1751	42 mm Superior
1752	42 mm Inferior

### Acero inoxidable AISI 303-304L

591	42 mm Juego
5911	42 mm Superior
5912	42 mm Inferior

## Punto de giro 60 mm con rodamiento



Cód.	Medidas
337	60 mm Juego
3371	60 mm Superior
3372	60 mm Inferior

### Acero inoxidable AISI 303-304L

590	60 mm Juego
5902	60 mm Superior
5903	60 mm Inferior

## Punto de giro 40 mm a bola



Cód.	Medidas
165	40 mm Juego
1651	40 mm Superior
1652	40 mm Inferior

## Maneta puerta elevable



Cód.	Medidas
448	Negra
449	Cromada

## Maneta regulable



Cód.	Medidas
41	Negra
275	Negra
36	Negra
37	Negra
4101	Cromada
38	Cromada
39	Cromada

## Pernio inferior con bola



Cód.	Medidas
563	20 mm
564	24 mm

**Ref.: 318 A**  
ACABADO: ZN

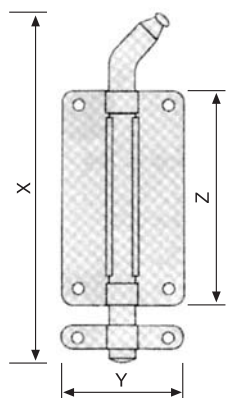

Ø 15

X	250	300	400	500	600
Y	70	70	70	70	70
Z	120	120	120	120	120

**Ref.: 318 B**  
ACABADO: ZN

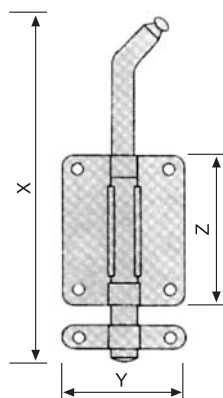

Ø 13

X	200	250	300	400	600	1000
Y	70	70	70	70	70	70
Z	85	85	85	85	85	85

**Ref.: 318 C**  
ACABADO: ZN

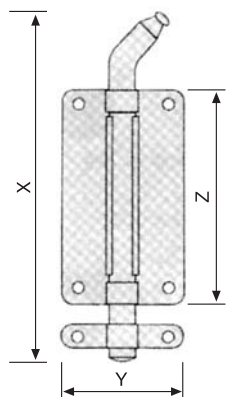

Ø 18

X	250	300	400
Y	65	65	65
Z	120	120	120

**Ref.: 319 B**  
ACABADO: ZN

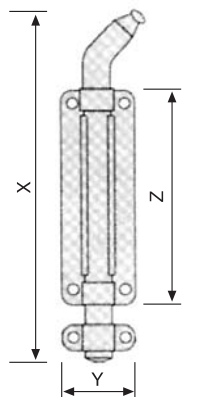

Ø 13

X	200	250	300	400	600	1000
Y	40	40	40	40	40	40
Z	85	85	85	85	85	85

## CERROJOS

**Ref.: 454**  
ACABADO: BICROMATADO

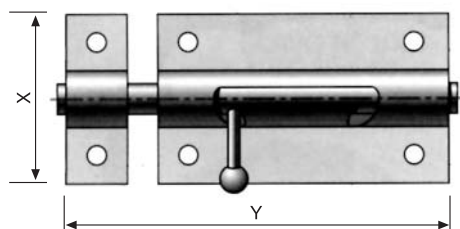

X	70	85	100	120
Y	65	70	70	70

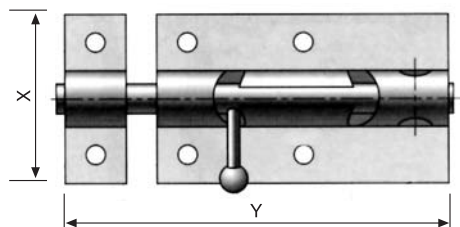

## VARILLAS

**Varilla roscada**  
ACABADO: ZINCADO

MÉTRICA

3 - 4 - 5 - 6 - 7 - 8 - 10 - 12 - 14  
16 - 18 - 20 - 22 - 24 - 27 - 30  
33 - 36 - 39

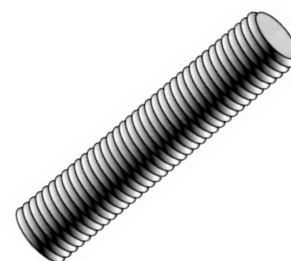

## TUERCAS - ARANDELAS

**Tuercas**  
ZINCADAS

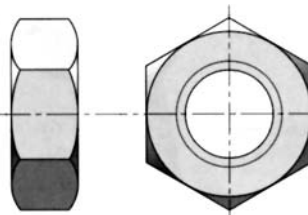

**Arandelas planas**  
ZINCADAS

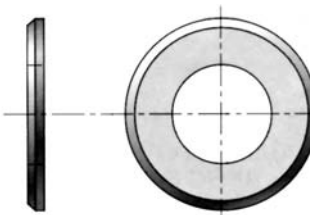

**Ref.: 123**  
ACABADO: HIERRO

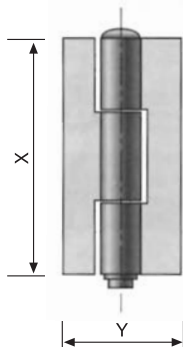

X	Y	E
80	50	3
100	60	4
150	70	4

**Ref.: 507**  
ACABADO: ZN

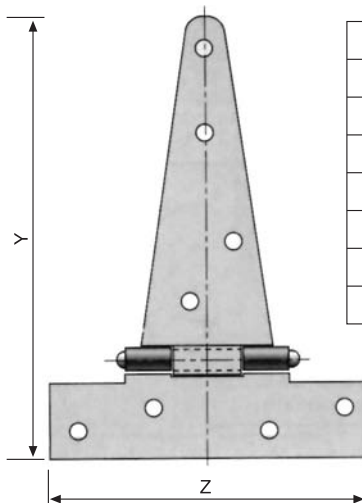

Y	Z
125	95
145	95
162	95
185	120
208	120
228	120
248	120

**Ref.: 502**  
ACABADO: HP

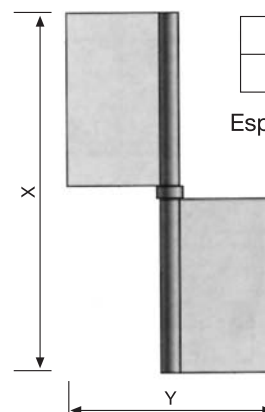

X	Y
80	55

Espesor 3 mm.

**Ref.: 500**  
ACABADO: HP

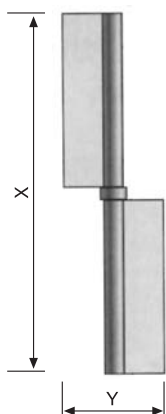

X	Y
83	22

Espesor 2,5 mm.

**Bisagra atornillar**  
**AISI 304**

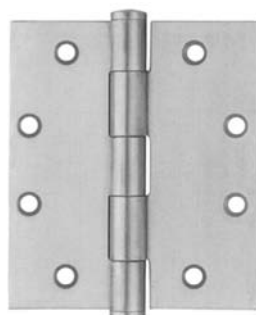

Cód.	Medidas
500SS	100 x 75 x 2,5 mm.
505SS	100 x 100 x 2,5 mm.

**Bisagra atornillar**  
**CON ARANDELA INOXIDABLE**  
**AISI 304**

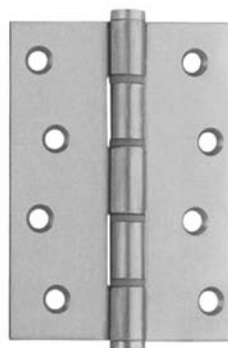

Cód.	Medidas
510SS	100 x 75 x 2,5 mm.
515SS	100 x 100 x 2,5 mm.

## CREMALLERAS

### Cremallera para puerta corredera

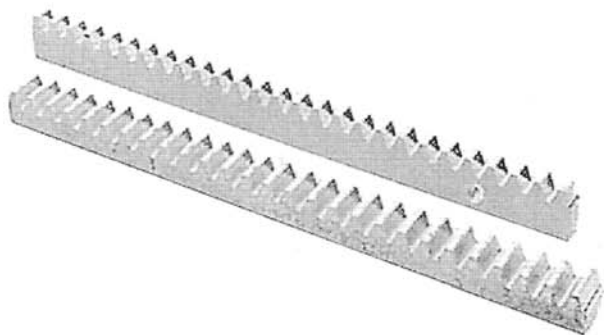

MEDIDAS  
22 x 22 x 1.000 (Cod. Art. 67.000)  
30 x 12 x 1.000 (Cod. Art. 67.010)  
Acabado: Hierro Zincado

