

Pinzas vidrio

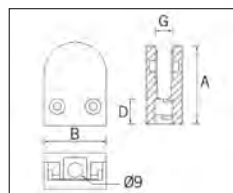

CC 700 BA AISI-316

| pcs/box | A | B | D | G |
|---------|----|----|----|---------|
| 10 | 50 | 40 | 16 | (6/8) |
| 10 | 50 | 40 | 16 | (8/10) |
| 10 | 50 | 40 | 16 | (10/12) |

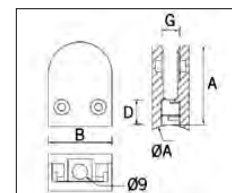

CC 701 BA AISI-316

| pcs/box | ØA | A | B | D | G |
|---------|------|----|----|----|---------|
| 10 | 38,1 | 50 | 40 | 16 | (6/8) |
| 10 | 43 | 50 | 40 | 16 | (6/8) |
| 10 | 50,8 | 50 | 40 | 16 | (6/8) |
| 10 | 43 | 50 | 40 | 16 | (8/10) |
| 10 | 50,8 | 50 | 40 | 16 | (8/10) |
| 10 | 50,8 | 50 | 40 | 16 | (10/12) |

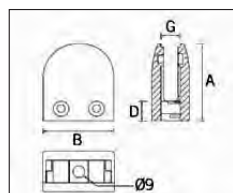

CC 702 BA AISI-316

| pcs/box | A | B | D | G |
|---------|----|----|------|---------|
| 5 | 60 | 55 | 15,5 | (10/12) |

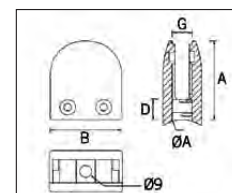

CC 703 BA AISI-316

| pcs/box | ØA | A | B | D | G |
|---------|------|----|----|------|---------|
| 5 | 38,1 | 60 | 55 | 15,5 | (10/12) |
| 5 | 43 | 60 | 55 | 15,5 | (10/12) |
| 5 | 50,8 | 60 | 55 | 15,5 | (10/12) |

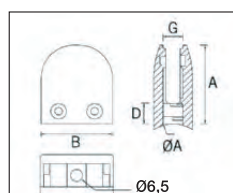

CC 705 BA AISI-316

| pcs/box | ØA | A | B | D | G |
|---------|------|----|----|------|-------|
| 10 | 50,8 | 55 | 55 | 15,5 | (6/8) |

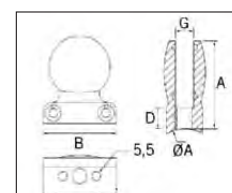

CC 707 BA AISI-316

| pcs/box | ØA | A | B | D | G |
|---------|------|----|----|----|--------|
| 10 | 43 | 53 | 45 | 13 | (8/10) |
| 10 | 50,8 | 53 | 45 | 13 | (8/10) |

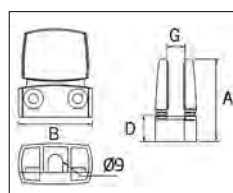

CC 708 AISI-316

| pcs/box | A | B | D | G |
|---------|----|----|----|-----------|
| 4 | 50 | 45 | 16 | (8/10,76) |

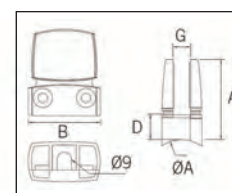

CC 709 BA AISI-316

| pcs/box | ØA | A | B | D | G |
|---------|------|----|----|----|-----------|
| 4 | 43 | 50 | 45 | 16 | (8/10,76) |
| 4 | 50,8 | 50 | 45 | 16 | (8/10,76) |

Pinzas vidrio

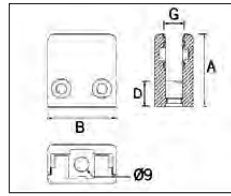

CC 720 BA AISI-316

| pcs/box | A | B | D | G |
|---------|----|----|----|--------|
| 4 | 44 | 44 | 16 | (8/10) |

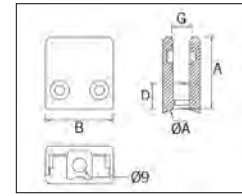

CC 721 BA AISI-316

| pcs/box | ØA | A | B | D | G |
|---------|------|----|----|----|--------|
| 4 | 43 | 44 | 44 | 16 | (8/10) |
| 4 | 50,8 | 44 | 44 | 16 | (8/10) |

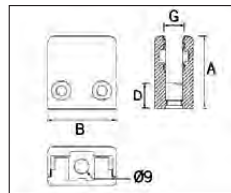

CC 722 BA AISI-316

| pcs/box | A | B | D | G |
|---------|----|----|----|---------|
| 4 | 54 | 54 | 16 | (10/12) |

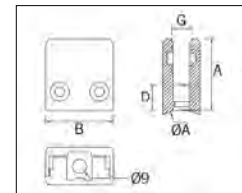

CC 723 BA AISI-316

| pcs/box | A | B | D | G |
|---------|------|----|----|----|
| 4 | 43 | 54 | 54 | 16 |
| 4 | 50,8 | 54 | 54 | 16 |

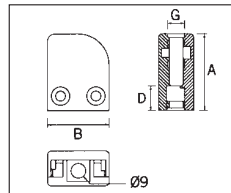

CC 750 BA AISI-316

| pcs/box | A | B | D | G | L/R |
|---------|----|----|----|--------|-----|
| 4 | 50 | 40 | 16 | (6/8) | L/R |
| 4 | 50 | 40 | 16 | (8/10) | L/R |

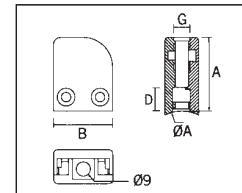

CC 751 BA AISI-316

| pcs/box | ØA | A | B | D | G | L/R |
|---------|------|----|----|----|--------|-----|
| 4 | 43 | 50 | 40 | 16 | (6/8) | L/R |
| 4 | 50,8 | 50 | 40 | 16 | (6/8) | L/R |
| 4 | 43 | 50 | 40 | 16 | (8/10) | L/R |
| 4 | 50,8 | 50 | 40 | 16 | (8/10) | L/R |

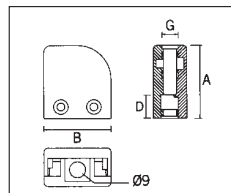

CC 752 BA AISI-316

| pcs/box | A | B | D | G | L/R |
|---------|----|----|----|---------|-----|
| 4 | 60 | 55 | 16 | (10/12) | L/R |

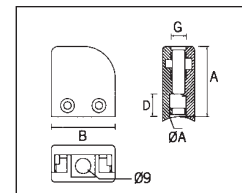

CC 753 BA AISI-316

| pcs/box | ØA | A | B | D | G | L/R |
|---------|------|----|----|----|---------|-----|
| 4 | 43 | 60 | 55 | 16 | (10/12) | L/R |
| 4 | 50,8 | 60 | 55 | 16 | (10/12) | L/R |

Sistema de arañas para barandillas



CC 759 BA AISI-316

| pcs/box | A | B | G |
|---------|-----|----|-----------|
| 2 | 120 | 38 | (6-17,52) |

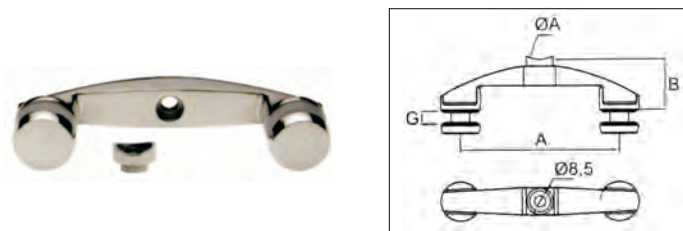

CC 760 BA AISI-316

| pcs/box | ØA | A | B | G |
|---------|------|-----|----|-----------|
| 2 | 38,1 | 120 | 38 | (6-17,52) |
| 2 | 43 | 120 | 38 | (6-17,52) |
| 2 | 50,8 | 120 | 38 | (6-17,52) |



CC 761 BA AISI-316

| pcs/box | A | B | G |
|---------|----|----|-----------|
| 2 | 60 | 38 | (6-17,52) |



CC 762 BA AISI-316

| pcs/box | ØA | A | B | G |
|---------|------|----|----|-----------|
| 2 | 38,1 | 60 | 38 | (6-17,52) |
| 2 | 43 | 60 | 38 | (6-17,52) |
| 2 | 50,8 | 60 | 38 | (6-17,52) |

Adaptador vidrio

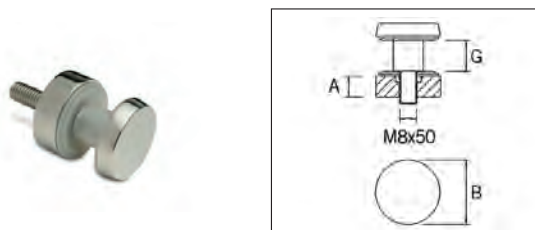

CC 768 BA AISI-316

| pcs/box | A | B | G |
|---------|----|----|-----------|
| 4 | 10 | 30 | (6-17,52) |

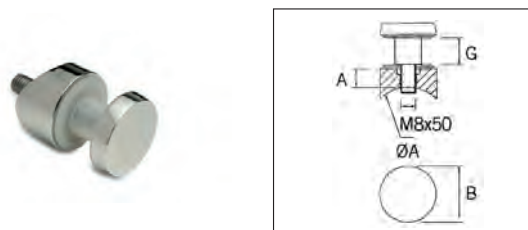

CC 769 BA AISI-316

| pcs/box | ØA | A | B | G |
|---------|------|----|----|-----------|
| 4 | 38,1 | 10 | 30 | (6-17,52) |
| 4 | 43 | 10 | 30 | (6-17,52) |
| 4 | 50,8 | 10 | 30 | (6-17,52) |

Soportes chapa

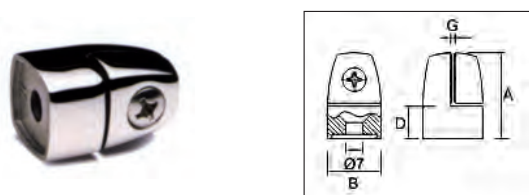

CC 770 BA AISI-316

| pcs/box | A | B | D | G |
|---------|----|----|----|-------|
| 4 | 40 | 25 | 15 | (1-4) |

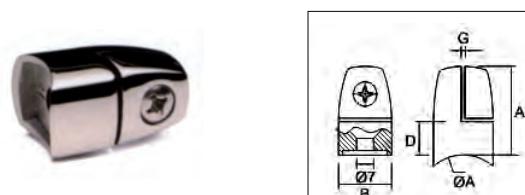

CC 771 BA AISI-316

| pcs/box | ØA | A | B | D | G |
|---------|------|----|----|----|-------|
| 4 | 50,8 | 40 | 25 | 15 | (1-4) |

Adaptador lateral vidrio

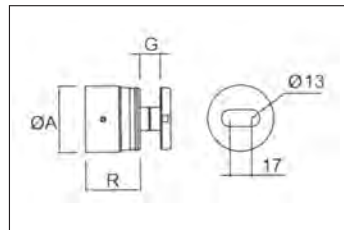

CC 775 BA AISI-316

| pcs/box | ØA | R | G |
|---------|----|-------|---------|
| 4 | 52 | 45-50 | 8-21,52 |

Pinzas vidrio para suelo

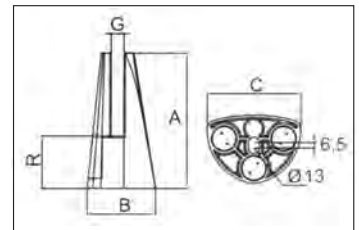

CC 780 BA AISI-316

| pcs/box | A | B | C | R | G |
|---------|-----|----|-----|-------|----------|
| 1 | 160 | 80 | 110 | 60-65 | 12-17,52 |

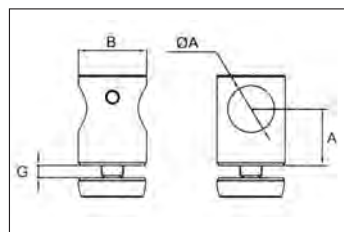

CC 790 BA AISI-316

| pcs/box | ØA | A | B | G |
|---------|----|----|----|--------|
| 4 | 16 | 20 | 25 | (6-15) |

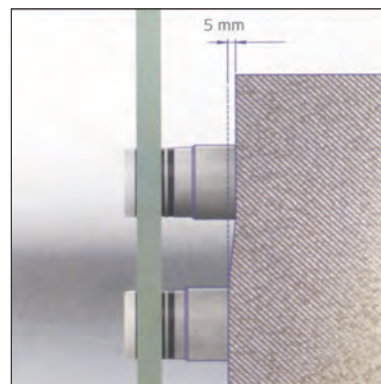

Bases y embellecedor

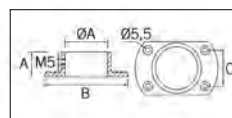

AV 600 BA AISI-316

| pcs/box | ØA | B | A | C |
|---------|------|----|----|----|
| 10 | 38,1 | 75 | 30 | 28 |
| 10 | 43 | 85 | 25 | 34 |
| 10 | 50,8 | 96 | 35 | 39 |

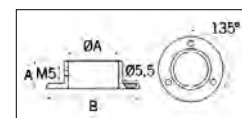

AV 601 BA AISI-316

| pcs/box | ØA | B | A |
|---------|------|-----|----|
| 10 | 38,1 | 75 | 24 |
| 10 | 43 | 80 | 25 |
| 10 | 50,8 | 102 | 31 |

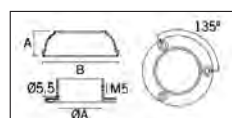

AV 602 BA AISI-316

| pcs/box | ØA | B | A |
|---------|------|----|----|
| 10 | 38,1 | 25 | 73 |
| 10 | 43 | 26 | 82 |
| 10 | 50,8 | 29 | 85 |

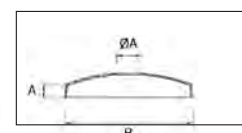

AV 651 BA AISI-316

| pcs/box | ØA | B | A |
|---------|------|----|---|
| 2 | 12,2 | 66 | 6 |
| 2 | 20 | 66 | 6 |

Bases y embellecedor

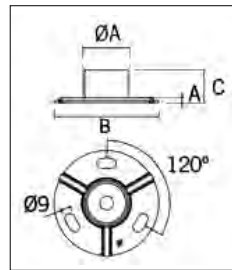

BS 00 BA AISI-316

| pcs/box | ØA | A | B | C | E* |
|---------|------|---|----|----|-----|
| 2 | 38,1 | 5 | 95 | 35 | 1,5 |
| 2 | 43 | 5 | 95 | 35 | 1,5 |
| 2 | 50,8 | 5 | 95 | 35 | 1,5 |

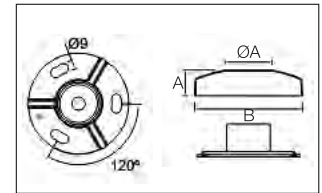
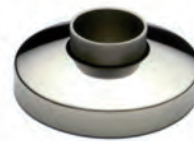

AV 603 BA AISI-316

| pcs/box | ØA | A | B | E* |
|---------|------|------|----|-----|
| 2 | 43 | 22,5 | 99 | 1,5 |
| 2 | 50,8 | 22,5 | 99 | 1,5 |

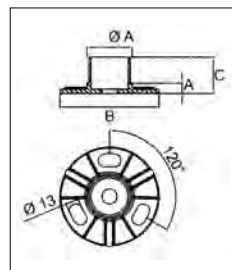

BS 01 BA AISI-316

| pcs/box | ØA | A | B | C | E* |
|---------|------|----|----|----|-----|
| 2 | 38,1 | 10 | 95 | 35 | 1,5 |
| 2 | 40 | 10 | 95 | 35 | 1,5 |
| 2 | 43 | 10 | 95 | 35 | 1,5 |
| 2 | 50,8 | 10 | 95 | 35 | 1,5 |

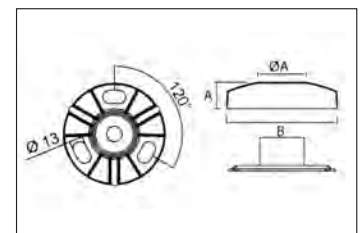

AV 604 BA AISI-316

| pcs/box | ØA | A | B | E* |
|---------|------|------|----|-----|
| 2 | 38,1 | 22,5 | 99 | 1,5 |
| 2 | 40 | 22,5 | 99 | 1,5 |
| 2 | 43 | 22,5 | 99 | 1,5 |
| 2 | 50,8 | 22,5 | 99 | 1,5 |

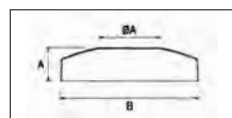

AV 650 BA AISI-316

| pcs/box | ØA | A | B |
|---------|------|------|-----|
| 4 | 20 | 11,5 | 55 |
| 2 | 38,1 | 22,5 | 99 |
| 2 | 40 | 22,5 | 99 |
| 2 | 43 | 22,5 | 99 |
| 2 | 50,8 | 22,5 | 99 |
| 2 | 63,5 | 24 | 110 |

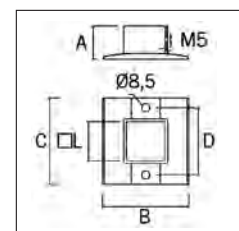

AV 610 BA AISI-316

| pcs/box | □L | A | □B | D |
|---------|-------|----|----|----|
| 2 | 40x40 | 35 | 90 | 70 |

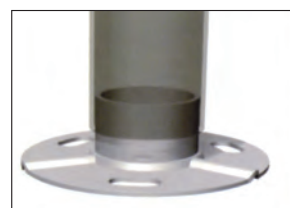
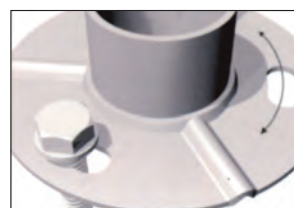

Bases y embellecedor

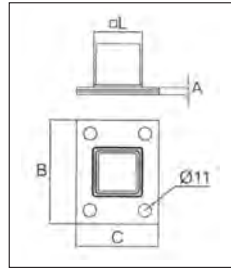
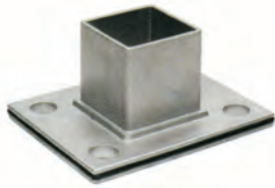

BS 10 BA AISI-316

| pcs/box | □L | A | B | C | E* |
|---------|-------|---|----|----|-----|
| 2 | 40x40 | 6 | 88 | 69 | 1,5 |

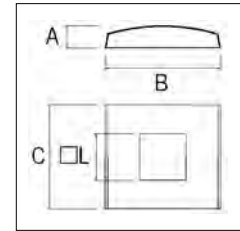
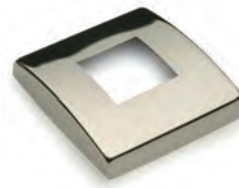

AV 660 BA AISI-316

| pcs/box | □L | A | B | C |
|---------|-------|----|-----|----|
| 2 | 40x40 | 18 | 100 | 90 |
| 2 | 50x50 | 18 | 100 | 90 |

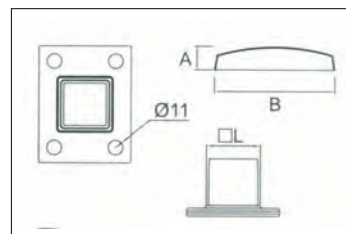
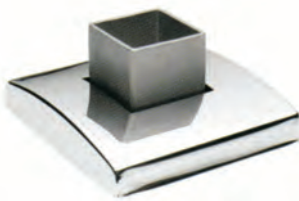

AV 611 BA AISI-316

| pcs/box | □L | A | B |
|---------|-------|----|-----|
| 2 | 40x40 | 18 | 100 |



Soporte lateral para barandillas

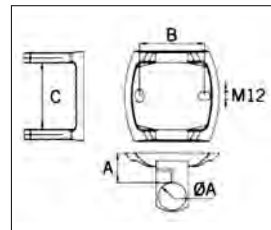

SL 1100 BA AISI-316

| pcs/box | ØA | B | C |
|---------|------|-----|-----|
| 1 | 38,1 | 100 | 120 |
| 1 | 43 | 100 | 120 |
| 1 | 50,8 | 100 | 120 |

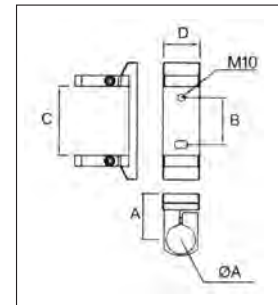

SL 1101 BA AISI-316

| pcs/box | ØA | A | B | C | D |
|---------|------|----|----|-----|----|
| 1 | 38,1 | 68 | 70 | 100 | 54 |
| 1 | 43 | 58 | 70 | 100 | 54 |
| 1 | 50,8 | 72 | 70 | 100 | 62 |

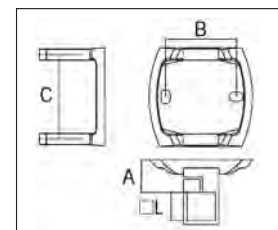

SL 1110 BA AISI-316

| pcs/box | □L | A | B | C |
|---------|-------|------|-----|-----|
| 1 | 40x40 | 46,5 | 100 | 120 |

Soporte lateral para barandillas

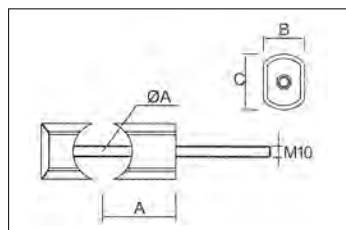

SL 1120 BA AISI-316

| kit/box | ØA | A | B | C |
|---------|------|----|----|----|
| 1 kit* | 38,1 | 51 | 25 | 30 |
| 1kit* | 43 | 53 | 30 | 40 |
| 1kit* | 50,8 | 57 | 30 | 40 |

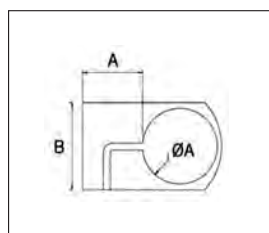

SL 1180 BA AISI-316

| pcs/box | ØA | A | B |
|---------|------|------|----|
| 2 | 38,1 | 34,5 | 50 |
| 2 | 43 | 34,5 | 50 |

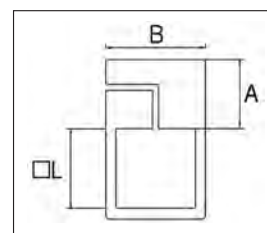

SL 1181 BA AISI-316

| pcs/box | □L | A | B |
|---------|-------|------|----|
| 2 | 40x40 | 34,5 | 50 |

Soportes barras mostrador

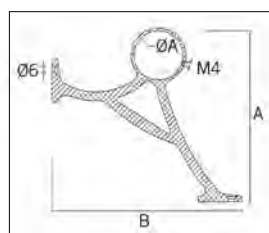

ST 300 BA AISI-316

| pcs/box | ØA | A | B |
|---------|------|-----|-----|
| 5 | 50,8 | 178 | 187 |

Soportes tubo

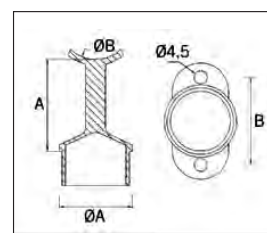

ST 302 BA AISI-316

| pcs/box | ØA | ØB | A | B | E* |
|---------|------|------|----|----|-----|
| 2 | 38,1 | 38,1 | 55 | 48 | 1,5 |
| 2 | 38,1 | 50,8 | 55 | 48 | 1,5 |
| 2 | 43 | 43 | 60 | 52 | 1,5 |
| 2 | 50,8 | 50,8 | 65 | 60 | 1,5 |

Soporte pasamanos pared

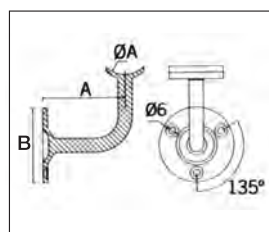

ST 303 BA AISI-316

| pcs/box | ØA | A | B |
|---------|------|----|----|
| 5 | 43 | 70 | 63 |
| 5 | 50,8 | 70 | 63 |



Soporte pasamanos pared

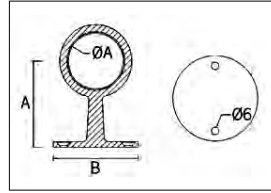

ST 304 BA AISI-316

| pcs/box | ØA | A | B |
|---------|------|----|----|
| 2 | 38,1 | 69 | 57 |
| 2 | 43 | 68 | 67 |
| 2 | 50,8 | 78 | 80 |

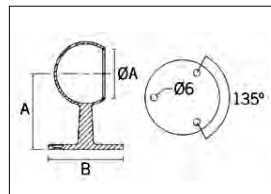

ST 305 BA AISI-316

| pcs/box | ØA | A | B |
|---------|------|----|----|
| 2 | 38,1 | 69 | 57 |
| 2 | 43 | 68 | 67 |
| 2 | 50,8 | 78 | 80 |

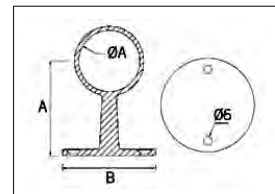

ST 306 BA AISI-316

| pcs/box | ØA | A | B |
|---------|------|----|----|
| 2 | 43 | 72 | 69 |
| 2 | 50,8 | 83 | 63 |

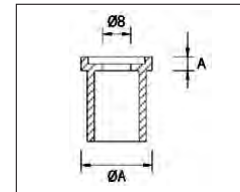
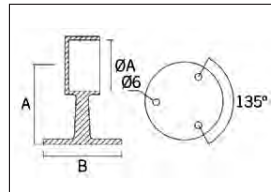

ST 307 BA AISI-316

| pcs/box | ØA | A | B |
|---------|------|----|----|
| 2 | 43 | 72 | 69 |
| 2 | 50,8 | 83 | 63 |

ST 308 BA AISI-316

| pcs/box | ØA | A | E* |
|---------|------|---|-----|
| 4 | *20 | 4 | 1,5 |
| 2 | 38,1 | 4 | 1,5 |
| 2 | 43 | 4 | 1,5 |
| 2 | 50,8 | 4 | 1,5 |

Adaptadores tubos

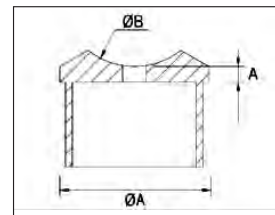
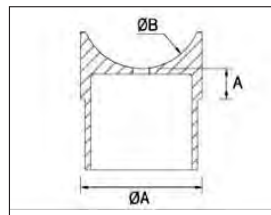

ST 309 BA AISI-316

| pcs/box | ØA | ØB | A | E* |
|---------|------|------|----|-----|
| 4 | 20 | 43 | 4 | 1,5 |
| 4 | 20 | 50,8 | 4 | 1,5 |
| 2 | 38,1 | 38,1 | 17 | 1,5 |
| 2 | 38,1 | 50,8 | 9 | 1,5 |
| 2 | 43 | 43 | 12 | 1,5 |
| 2 | 50,8 | 50,8 | 9 | 1,5 |

ST 310 BA AISI-316

| pcs/box | ØA | ØB | A | E* |
|---------|------|------|---|-----|
| 4 | 20 | 43 | 4 | 1,5 |
| 4 | 20 | 50,8 | 4 | 1,5 |
| 2 | 38,1 | 38,1 | 5 | 1,5 |
| 2 | 38,1 | 50,8 | 5 | 1,5 |
| 2 | 43 | 43 | 5 | 1,5 |
| 2 | 50,8 | 50,8 | 5 | 1,5 |

SopORTE pasamanos pared

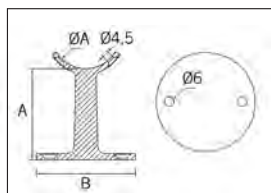

ST 311 BA AISI-316

| pcs/box | ØA | A | B |
|---------|------|----|------|
| 2 | 43 | 57 | 62,5 |
| 2 | 50,8 | 57 | 62,5 |



ST 311, TF 501

SopORTE pasamanos lateral

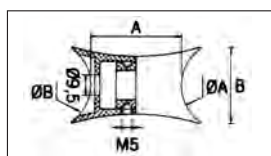

ST 312 BA AISI-316

| pcs/box | ØA | ØB | A | B |
|---------|------|------|----|----|
| 2 | 43 | 43 | 44 | 37 |
| 2 | 50,8 | 50,8 | 44 | 37 |

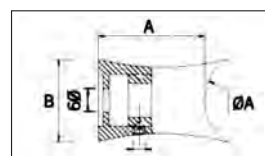

ST 313 BA AISI-316

| pcs/box | ØA | A | B |
|---------|----|----|----|
| 2 | 40 | 44 | 34 |

SopORTE pasamanos vidrio

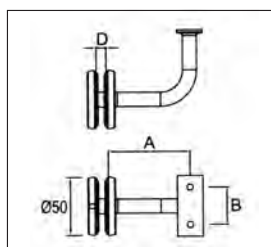

ST 314 BA AISI-316

| pcs/box | ØA | A | B | D |
|---------|------|----|----|-----------|
| 2 | 38,1 | 70 | 32 | (6-21,52) |
| 2 | 43 | 70 | 32 | (6-21,52) |
| 2 | 50,8 | 70 | 32 | (6-21,52) |

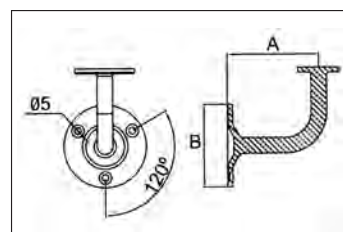

ST 315 BA AISI-316

| pcs/box | A | B | D |
|---------|----|----|-----------|
| 2 | 70 | 32 | (6-21,52) |

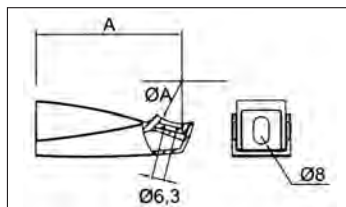

ST 317 BA AISI-316

| pcs/box | ØA | A |
|---------|------|----|
| 2 | 43 | 75 |
| 2 | 50,8 | 75 |

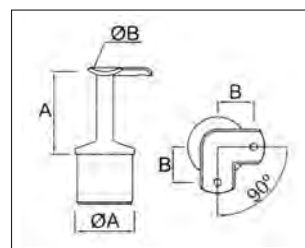

ST 319 BA AISI-316

| pcs/box | ØA | ØB | A | B | E* |
|---------|------|------|----|----|-----|
| 2 | 38,1 | 38,1 | 55 | 24 | 1,5 |
| 2 | 38,1 | 50,8 | 55 | 24 | 1,5 |
| 2 | 43 | 43 | 60 | 24 | 1,5 |
| 2 | 50,8 | 50,8 | 65 | 30 | 1,5 |

Soportes transversales

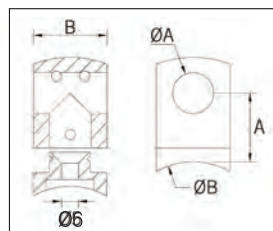

ST 320 BA AISI-316

| pcs/box | ØA | ØB | A | B |
|---------|----|------|----|----|
| 4 | 12 | 43 | 20 | 21 |
| 4 | 12 | 50,8 | 20 | 21 |
| 4 | 14 | 43 | 21 | 23 |
| 4 | 14 | 50,8 | 21 | 23 |
| 4 | 16 | 43 | 25 | 26 |
| 4 | 16 | 50,8 | 25 | 26 |
| 4 | 20 | 43 | 25 | 30 |
| 4 | 20 | 50,8 | 25 | 30 |

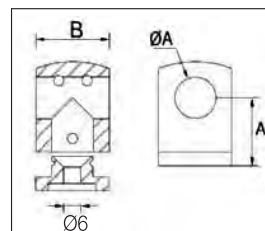

ST 321 BA AISI-316

| pcs/box | ØA | A | B |
|---------|----|----|----|
| 4 | 12 | 20 | 21 |
| 4 | 14 | 21 | 23 |
| 4 | 16 | 25 | 26 |
| 4 | 20 | 25 | 30 |

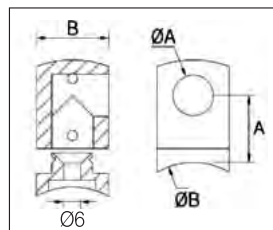
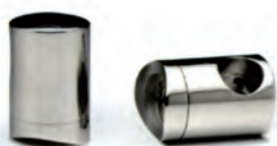

ST 322 BA AISI-316

| pcs/box | ØA | ØB | A | B | L/R |
|---------|----|------|----|----|-----|
| 4 | 12 | 43 | 21 | 20 | L/R |
| 4 | 12 | 50,8 | 20 | 21 | L/R |
| 4 | 16 | 43 | 25 | 23 | L/R |
| 4 | 16 | 50,8 | 25 | 23 | L/R |
| 4 | 20 | 43 | 25 | 30 | L/R |
| 4 | 20 | 50,8 | 25 | 30 | L/R |

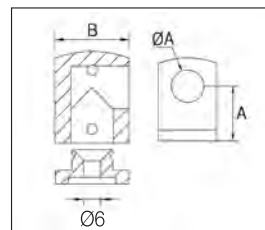

ST 323 BA AISI-316

| pcs/box | ØA | A | B | L/R |
|---------|----|----|----|-----|
| 4 | 12 | 20 | 21 | L/R |
| 4 | 16 | 25 | 26 | L/R |
| 4 | 20 | 25 | 30 | L/R |

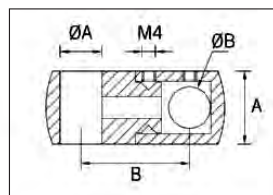

ST 324 BA AISI-316

| pcs/box | ØA | ØB | A | B |
|---------|----|----|----|----|
| 4 | 12 | 12 | 21 | 25 |

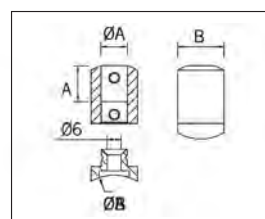

ST 325 BA AISI-316

| pcs/box | ØA | ØB | A | B |
|---------|----|------|------|------|
| 4 | 12 | 43 | 16,5 | 21,5 |
| 4 | 12 | 50,8 | 16,5 | 21,5 |



ST 322

Soportes transversales

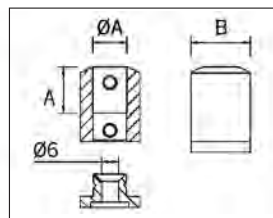

ST 326 BA AISI-316

| pcs/box | ØA | A | B |
|---------|----|----|----|
| 4 | 12 | 16 | 21 |

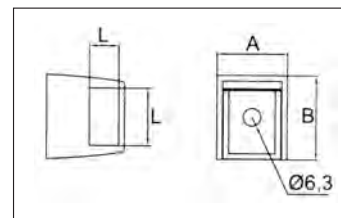

ST 328 BA AISI-316

| pcs/box | L | L' | A | B |
|---------|----|----|----|----|
| 4 | 20 | 10 | 25 | 28 |

Soportes tubo

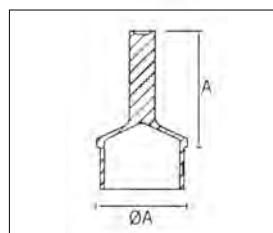

ST 330 BA AISI-316

| pcs/box | ØA | A | E* |
|---------|------|----|-----|
| 2 | 38,1 | 55 | 1,5 |
| 2 | 43 | 55 | 1,5 |
| 2 | 50,8 | 55 | 1,5 |

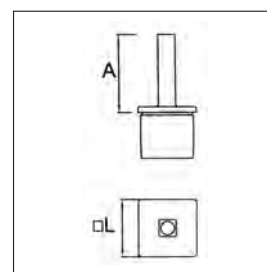

ST 331 BA AISI-316

| pcs/box | □L | A | E* |
|---------|-------|----|-----|
| 2 | 40x40 | 55 | 1,5 |

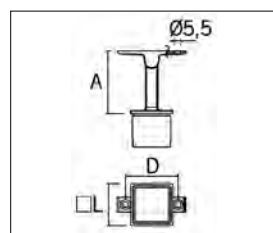

ST 332 BA AISI-316

| pcs/box | □L | A | D | E* |
|---------|-------|----|----|-----|
| 2 | 40x40 | 60 | 50 | 1,5 |

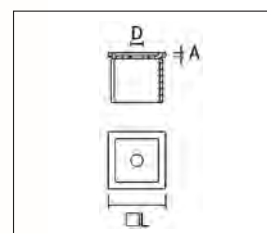

ST 333 BA AISI-316

| pcs/box | □L | A | D | E* |
|---------|-------|---|-----|-----|
| 4 | 20x20 | 4 | 6,5 | 1,5 |
| 2 | 30x30 | 3 | 8,5 | 1,5 |
| 2 | 40x40 | 3 | 8,5 | 1,5 |

Soportes barra

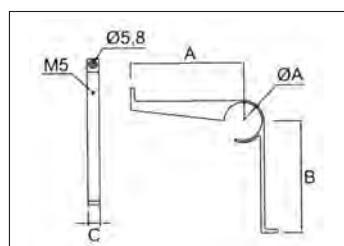

ST 336 BA AISI-316

| pcs/box | ØA | A | B | C |
|---------|------|-----|-----|----|
| 2 | 50,8 | 150 | 150 | 16 |

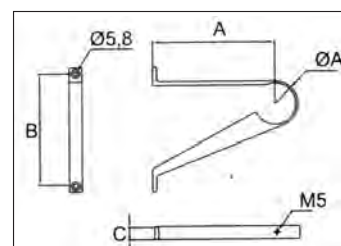

ST 337 BA AISI-316

| pcs/box | ØA | A | B | C |
|---------|------|-----|-----|----|
| 2 | 50,8 | 150 | 140 | 16 |

Soporte pasamanos pared

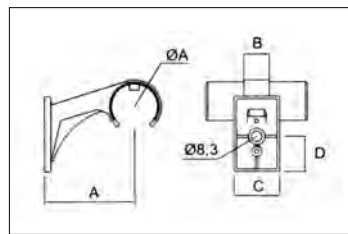

ST 345 BA AISI-316

| pcs/box | ØA | A | B | C | D |
|---------|------|----|----|----|----|
| 2 | 42,4 | 71 | 20 | 36 | 28 |

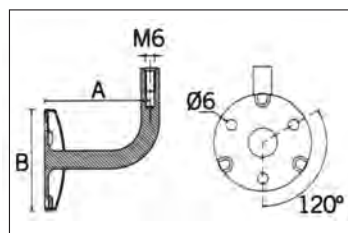

ST 352 BA AISI-316

| pcs/box | A | B |
|---------|----|----|
| 2 | 69 | 66 |

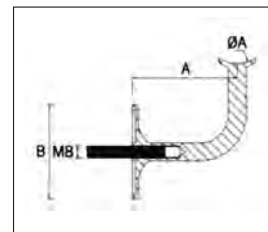

ST 340 BA AISI-316

| pcs/box | ØA | A | B | D | G |
|---------|------|----|----|----|-------|
| 2 | 43 | 70 | 63 | 16 | (6/8) |
| 2 | 50,8 | 70 | 63 | 16 | (6/8) |

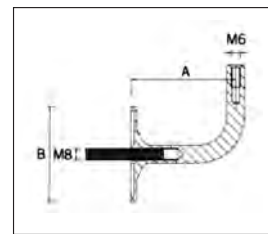

ST 350 BA AISI-316

| pcs/box | A | B |
|---------|----|----|
| 2 | 70 | 63 |

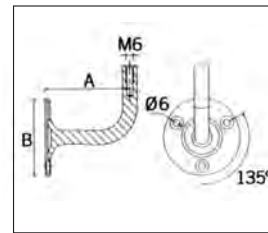

ST 351 BA AISI-316

| pcs/box | A | B |
|---------|----|----|
| 2 | 70 | 63 |

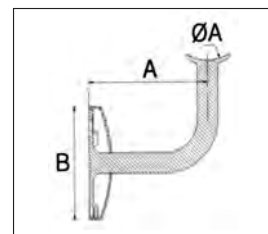

ST 353 BA AISI-316

| pcs/box | ØA | A | B |
|---------|------|----|----|
| 2 | 38,1 | 69 | 66 |
| 2 | 43 | 69 | 66 |
| 2 | 50,8 | 69 | 66 |



Barras y adaptadores tubo

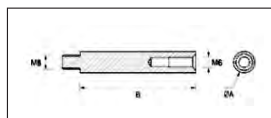

ST 380 BA AISI-316

| pcs/box | ØA | B |
|---------|----|----|
| 2 | 12 | 65 |

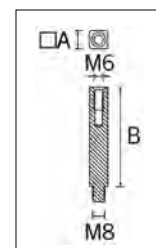

ST 381 BA AISI-316

| pcs/box | □A | B |
|---------|----|----|
| 2 | 12 | 65 |

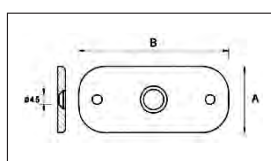

ST 390 BA AISI-316

| pcs/box | A | B |
|---------|----|------|
| 4 | 30 | 68,5 |

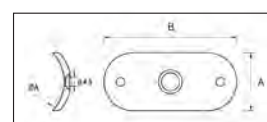

ST 391 BA AISI-316

| pcs/box | ØA | A | B |
|---------|------|----|------|
| 4 | 43 | 30 | 68,5 |
| 4 | 50,8 | 30 | 78,5 |

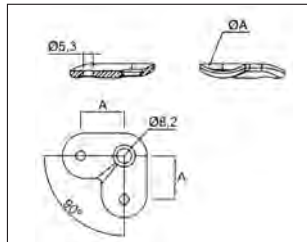

ST 392 BA AISI-316

| pcs/box | ØA | A |
|---------|------|----|
| 4 | 38,1 | 24 |
| 4 | 43 | 24 |
| 4 | 50,8 | 24 |

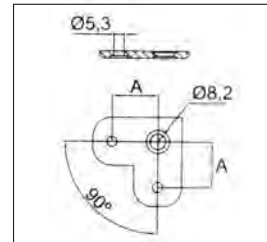

ST 393 BA AISI-316

| pcs/box | A |
|---------|----|
| 4 | 24 |

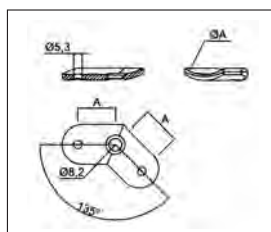

ST 394 BA AISI-316

| pcs/box | ØA | A |
|---------|------|----|
| 4 | 38,1 | 24 |
| 4 | 43 | 24 |
| 4 | 50,8 | 24 |

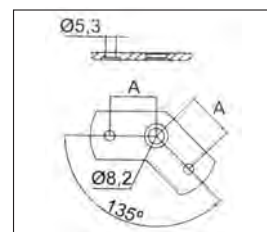

ST 395 BA AISI-316

| pcs/box | A |
|---------|----|
| 4 | 24 |

Codos y conectores tubo

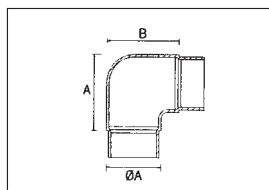

CT 200 BA AISI-316

| pcs/box | ØA | A | B | E* |
|---------|------|----|----|-----|
| 2 | 38,1 | 55 | 55 | 1,5 |
| 2 | 43 | 55 | 55 | 1,5 |
| 2 | 50,8 | 60 | 60 | 1,5 |

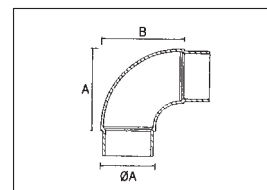

CT 201 BA AISI-316

| pcs/box | ØA | A | B | E* |
|---------|------|----|----|-----|
| 4 | 20 | 30 | 30 | 1,5 |
| 2 | 43 | 55 | 55 | 1,5 |
| 2 | 50,8 | 60 | 60 | 1,5 |

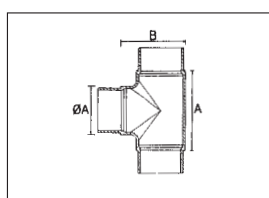

CT 202 BA AISI-316

| pcs/box | ØA | A | B | E* |
|---------|------|----|----|-----|
| 2 | 43 | 71 | 57 | 1,5 |
| 2 | 50,8 | 69 | 60 | 1,5 |

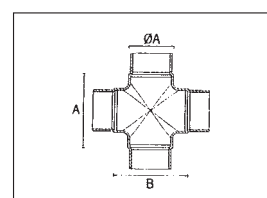

CT 203 BA AISI-316

| pcs/box | ØA | A | B | E* |
|---------|------|----|----|-----|
| 2 | 43 | 71 | 71 | 1,5 |
| 2 | 50,8 | 69 | 69 | 1,5 |

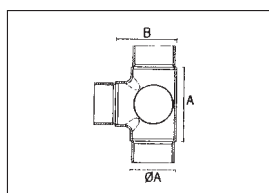

CT 204 BA AISI-316

| pcs/box | ØA | AB | E* |
|---------|------|----|----|
| 2 | 43 | 70 | 57 |
| 2 | 50,8 | 69 | 60 |

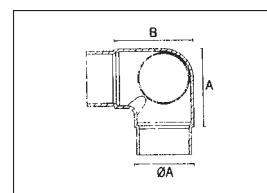

CT 205 BA AISI-316

| pcs/box | ØA | A | B | E* |
|---------|------|----|----|-----|
| 2 | 43 | 55 | 55 | 1,5 |
| 2 | 50,8 | 60 | 60 | 1,5 |

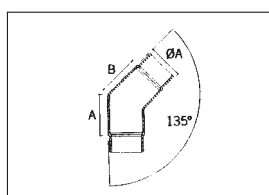

CT 206 BA AISI-316

| pcs/box | ØA | A | B | E* |
|---------|------|----|----|-----|
| 2 | 43 | 50 | 50 | 1,5 |
| 2 | 50,8 | 50 | 50 | 1,5 |

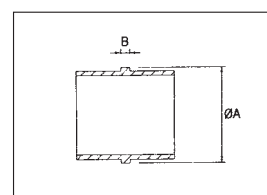

CT 207 BA AISI-316

| pcs/box | ØA | B | E* |
|---------|------|----|-----|
| 4 | 12 | 2 | 1 |
| 4 | 20 | 4 | 1,5 |
| 2 | 38,1 | 4 | 1,5 |
| 2 | 43 | 4 | 1,5 |
| 2 | 50,8 | 10 | 1,5 |

Codos y conectores tubo

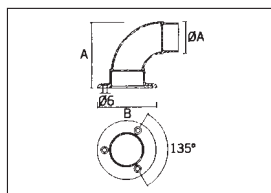

CT 208 BA AISI-316

| pcs/box | ØA | A | B | E* |
|---------|------|----|-----|-----|
| 2 | 38,1 | 83 | 75 | 1,5 |
| 2 | 43 | 90 | 80 | 1,5 |
| 2 | 50,8 | 95 | 102 | 1,5 |

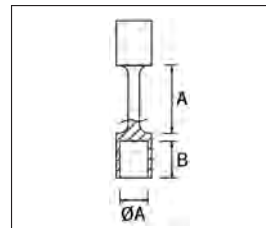

CT 209 BA AISI-316

| pcs/box | ØA | A | B |
|---------|----|----|------|
| 2 | 12 | 30 | 16,5 |

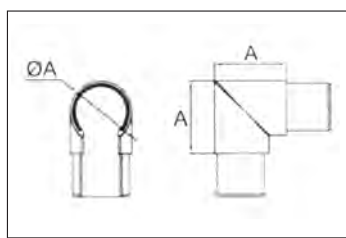

CT 210 BA AISI-316

| pcs/box | ØA | A | E* |
|---------|------|----|-----|
| 2 | 42,4 | 50 | 1,5 |

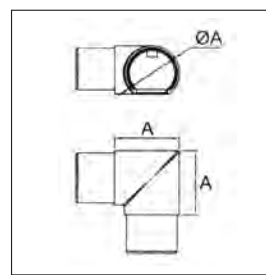

CT 211 BA AISI-316

| pcs/box | ØA | A |
|---------|------|----|
| 2 | 42,4 | 50 |

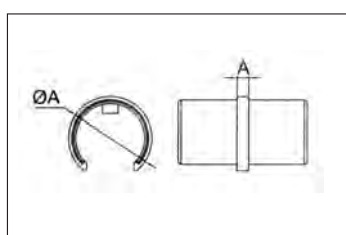

CT 212 BA AISI-316

| pcs/box | ØA | A |
|---------|------|---|
| 2 | 42,4 | 6 |

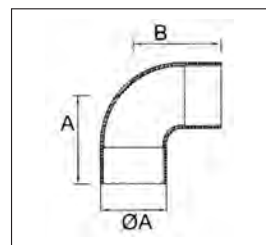

CT 215 BA AISI-316

| pcs/box | ØA | A | B |
|---------|----|----|----|
| 2 | 45 | 60 | 60 |

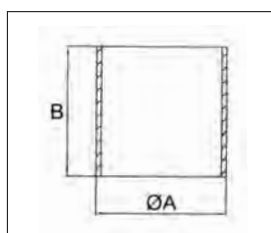

CT 216 BA AISI-316

| pcs/box | ØA | B |
|---------|----|----|
| 2 | 45 | 45 |

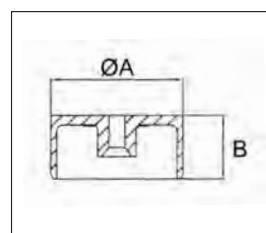

CT 217 BA AISI-316

| pcs/box | ØA | A |
|---------|----|----|
| 2 | 45 | 20 |

Codos y conectores tubo

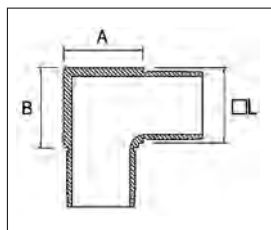

CT 220 BA AISI-316

| pcs/box | □L | A | B | E* |
|---------|-------|----|----|-----|
| 2 | 40x40 | 43 | 43 | 1,5 |

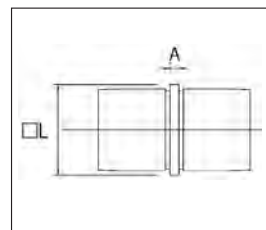

CT 221 BA AISI-316

| pcs/box | □L | A | E* |
|---------|-------|---|-----|
| 4 | 20x20 | 4 | 1,5 |
| 2 | 30x30 | 4 | 1,5 |
| 2 | 40x40 | 4 | 1,5 |
| 2 | 50x50 | 4 | 1,5 |

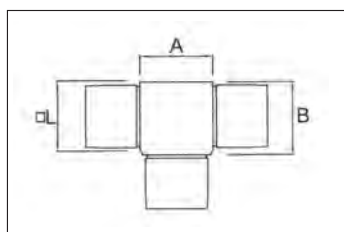

CT 222 BA AISI-316

| pcs/box | □L | A | B | E* |
|---------|-------|----|----|-----|
| 2 | 40x40 | 43 | 43 | 1,5 |

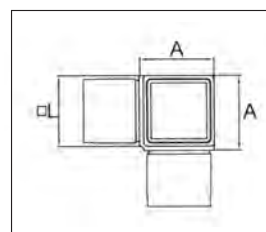

CT 225 BA AISI-316

| pcs/box | □L | A | E* |
|---------|-------|----|-----|
| 2 | 40x40 | 43 | 1,5 |

Soportes, codos y conectores de tubo

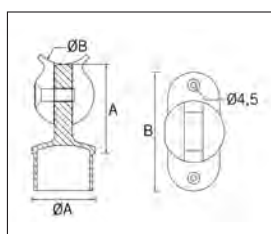

SA 400 BA AISI-316

| pcs/box | ØA | ØB | A | B | E* |
|---------|----|------|----|----|-----|
| 4 | 20 | 43 | 28 | 48 | 1,5 |
| 4 | 20 | 50,8 | 28 | 48 | 1,5 |

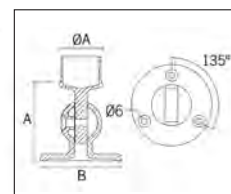

SA 401 BA AISI-316

| pcs/box | ØA | A | B | E* |
|---------|------|----|-----|-----|
| 2 | 43 | 80 | 85 | 1,5 |
| 2 | 50,8 | 84 | 101 | 1,5 |

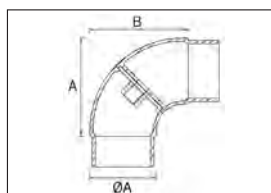

SA 402 BA AISI-316

| pcs/box | ØA | A | B | E* | α |
|---------|------|----|----|-----|--------|
| 2 | 43 | 65 | 65 | 1,5 | 90-180 |
| 2 | 50,8 | 78 | 78 | 1,5 | 90-180 |

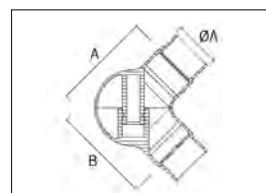

SA 403 BA AISI-316

| pcs/box | ØA | A | B | E* |
|---------|------|-----|-----|-----|
| 4 | 43 | 90 | 90 | 1,5 |
| 2 | 50,8 | 105 | 105 | 1,5 |

Soportes, codos y conectores de tubo

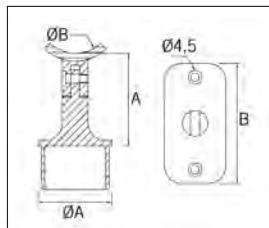

SA 404 BA AISI-316

| pcs/box | ØA | ØB | A | B | E* |
|---------|------|------|----|----|-----|
| 2 | 38,1 | 38,1 | 55 | 48 | 1,5 |
| 2 | 38,1 | 50,8 | 55 | 48 | 1,5 |
| 2 | 43 | 43 | 60 | 52 | 1,5 |
| 2 | 50,8 | 50,8 | 65 | 60 | 1,5 |

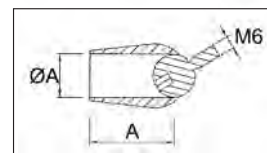

SA 405 BA AISI-316

| pcs/box | ØA | A |
|---------|----|----|
| 4 | 12 | 31 |
| 4 | 20 | 42 |

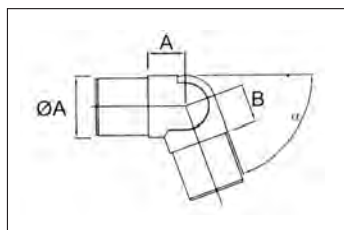

SA 406 BA AISI-316

| pcs/box | ØA | A | B | E* | α |
|---------|------|----|----|-----|------|
| 4 | 12 | 8 | 8 | 1 | 0-90 |
| 4 | 20 | 13 | 13 | 1,5 | 0-70 |
| 2 | 38,1 | 23 | 23 | 1,5 | 0-70 |
| 2 | 43 | 26 | 26 | 1,5 | 0-70 |
| 2 | 50,8 | 32 | 32 | 1,5 | 0-70 |

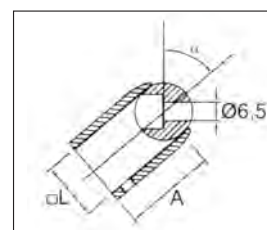

SA 407 BA AISI-316

| pcs/box | ØA | A | α |
|---------|-------|----|-----|
| 4 | 20x20 | 32 | 50° |

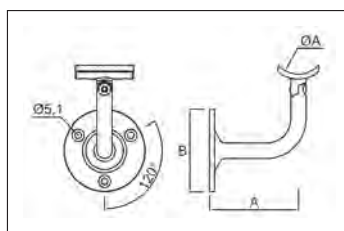

SA 410 BA AISI-316

| pcs/box | ØA | A | B |
|---------|------|----|----|
| 2 | 38,1 | 70 | 63 |
| 2 | 43 | 70 | 63 |
| 2 | 50,8 | 70 | 63 |

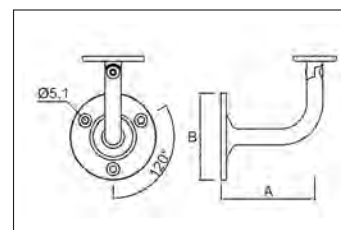

SA 411 BA AISI-316

| pcs/box | A | B |
|---------|----|----|
| 2 | 70 | 63 |

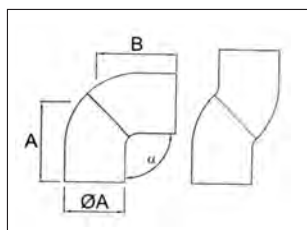

SA 412 BA AISI-316

| pcs/box | ØA | A | B | α |
|---------|----|----|----|--------|
| 2 | 45 | 60 | 60 | 90-180 |

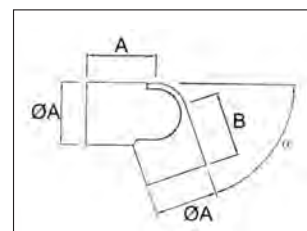

SA 413 BA AISI-316

| pcs/box | ØA | A | B | α |
|---------|----|----|----|------|
| 2 | 45 | 50 | 45 | 0-70 |

Soportes tubo

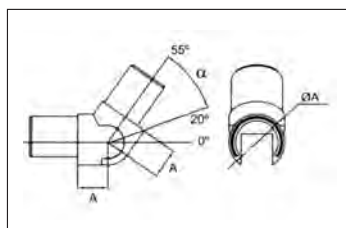

SA 416 BA AISI-316

| pcs/box | ØA | A | α |
|---------|------|----|--------|
| 2 | 42,4 | 23 | 20-55° |

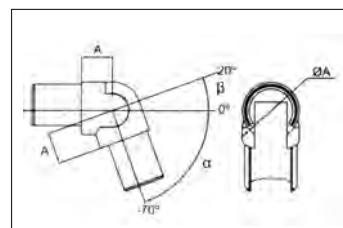

SA 417 BA AISI-316

| pcs/box | ØA | A | α | β |
|---------|------|----|-------|-------|
| 2 | 42,4 | 23 | 0-70° | 0-20° |

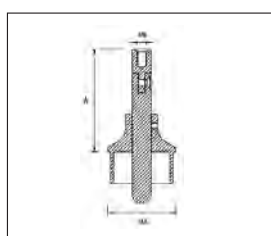

SA 420 (BG 00) BA AISI-316

| pcs/box | ØA | A | E* |
|---------|------|--------|-----|
| 2 | 43 | 30-100 | 1,5 |
| 2 | 50,8 | 30-100 | 1,5 |

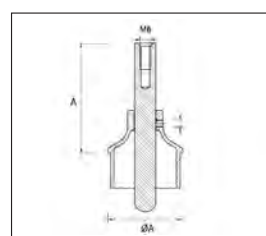

SA 420 (BF 00) BA AISI-316

| pcs/box | ØA | A | E* |
|---------|------|--------|-----|
| 2 | 43 | 30-100 | 1,5 |
| 2 | 50,8 | 30-100 | 1,5 |

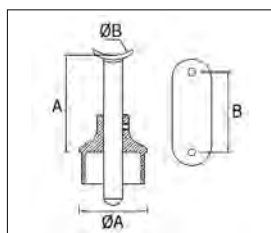

SA 420 (BG R) BA AISI-316

| pcs/box | ØA | ØB | A | B | E* |
|---------|------|------|--------|------|-----|
| 2 | 43 | 43 | 30-100 | 51,5 | 1,5 |
| 2 | 43 | 50,8 | 30-100 | 61,5 | 1,5 |
| 2 | 50,8 | 43 | 30-100 | 51,5 | 1,5 |
| 2 | 50,8 | 50,8 | 30-100 | 61,5 | 1,5 |

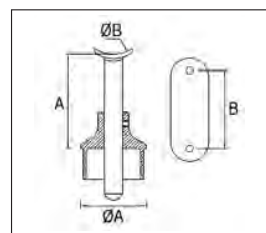

SA 420 (BF R) BA AISI-316

| pcs/box | ØA | ØB | A | B | E* |
|---------|------|------|--------|------|-----|
| 2 | 43 | 43 | 30-100 | 51,5 | 1,5 |
| 2 | 43 | 50,8 | 30-100 | 61,5 | 1,5 |
| 2 | 50,8 | 43 | 30-100 | 51,5 | 1,5 |
| 2 | 50,8 | 50,8 | 30-100 | 61,5 | 1,5 |

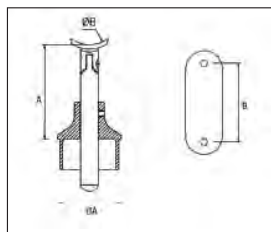

SA 420 (BG FLAT) BA AISI-316

| pcs/box | ØA | A | B | E* |
|---------|------|--------|------|-----|
| 2 | 43 | 30-100 | 51,5 | 1,5 |
| 2 | 50,8 | 30-100 | 51,5 | 1,5 |

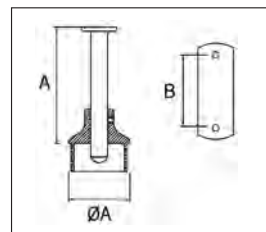

SA 420 (BF FLAT) BA AISI-316

| pcs/box | ØA | A | B | E* |
|---------|------|--------|------|-----|
| 2 | 43 | 30-100 | 51,5 | 1,5 |
| 2 | 50,8 | 30-100 | 51,5 | 1,5 |

Soportes pasamanos lateral articulado

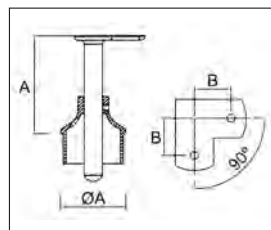

SA 420 (BFC FLAT 90) BA AISI-316

| pcs/box | ØA | A | B | E* |
|---------|------|--------|----|-----|
| 2 | 43 | 30-100 | 24 | 1,5 |
| 2 | 50,8 | 30-100 | 24 | 1,5 |

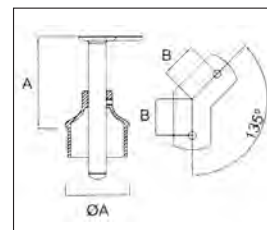

SA 420 (BFC FLAT 135) BA AISI-316

| pcs/box | ØA | A | B | E* |
|---------|------|--------|----|-----|
| 2 | 43 | 30-100 | 24 | 1,5 |
| 2 | 50,8 | 30-100 | 24 | 1,5 |

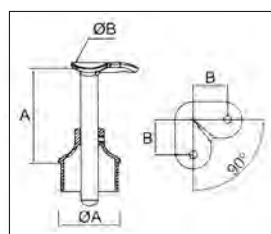

SA 420 (BFC R 90) BA AISI-316

| pcs/box | ØA | ØB | A | B | E* |
|---------|------|------|--------|----|-----|
| 2 | 43 | 43 | 30-100 | 24 | 1,5 |
| 2 | 43 | 50,8 | 30-100 | 24 | 1,5 |
| 2 | 50,8 | 43 | 30-100 | 24 | 1,5 |
| 2 | 50,8 | 50,8 | 30-100 | 24 | 1,5 |

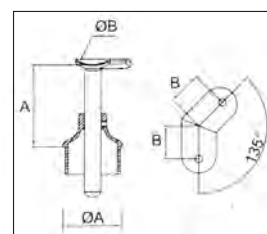

SA 420 (BFC R 135) BA AISI-316

| pcs/box | ØA | ØB | A | B | E* |
|---------|------|------|--------|----|-----|
| 2 | 43 | 43 | 30-100 | 24 | 1,5 |
| 2 | 43 | 50,8 | 30-100 | 24 | 1,5 |
| 2 | 50,8 | 43 | 30-100 | 24 | 1,5 |
| 2 | 50,8 | 50,8 | 30-100 | 24 | 1,5 |

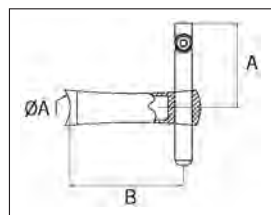

SA 421 (BG 00) BA AISI-316

| pcs/box | ØA | A | B |
|---------|------|-------|----|
| 2 | 43 | 30-70 | 80 |
| 2 | 50,8 | 30-70 | 80 |

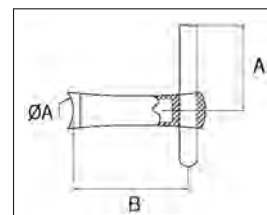

SA 421 (BF 00) BA AISI-316

| pcs/box | ØA | A | B |
|---------|------|-------|----|
| 2 | 43 | 30-70 | 80 |
| 2 | 50,8 | 30-70 | 80 |

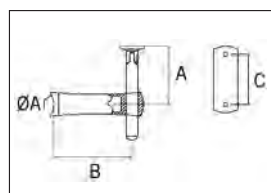

SA 421 (BG R) BA AISI-316

| pcs/box | ØA | ØB | A | B | C |
|---------|------|------|-------|----|------|
| 2 | 43 | 43 | 30-70 | 80 | 51,5 |
| 2 | 43 | 50,8 | 30-70 | 80 | 61,5 |
| 2 | 50,8 | 43 | 30-70 | 80 | 51,5 |
| 2 | 50,8 | 50,8 | 30-70 | 80 | 61,5 |

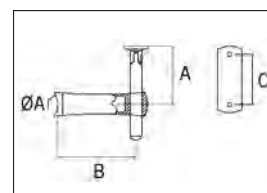

SA 421 (BG R) BA AISI-316

| pcs/box | ØA | ØB | A | B | C |
|---------|------|------|-------|----|------|
| 2 | 43 | 43 | 30-70 | 80 | 51,5 |
| 2 | 43 | 50,8 | 30-70 | 80 | 61,5 |
| 2 | 50,8 | 43 | 30-70 | 80 | 51,5 |
| 2 | 50,8 | 50,8 | 30-70 | 80 | 61,5 |

Soportes pasamanos lateral articulado

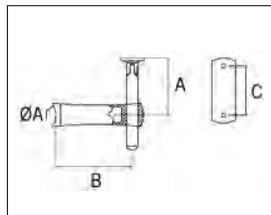

SA 421 (BG FLAT) BA AISI-316

| pcs/box | ØA | A | B | C |
|---------|------|-------|----|------|
| 2 | 43 | 30-70 | 80 | 51,5 |
| 2 | 50,8 | 30-70 | 80 | 51,5 |

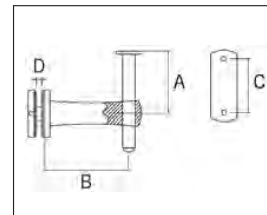

SA 421 (BF FLAT) BA AISI-316

| pcs/box | ØA | A | B | C |
|---------|------|-------|----|------|
| 2 | 43 | 30-70 | 80 | 51,5 |
| 2 | 50,8 | 30-70 | 80 | 51,5 |

Soportes pasamanos vidrio

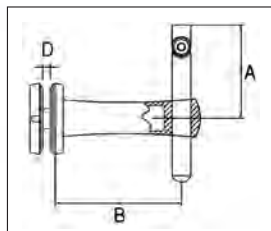

SA 423 (BG 00) BA AISI-316

| pcs/box | A | B | D |
|---------|--------|----|---------|
| 2 | 30-100 | 80 | 6-17,52 |

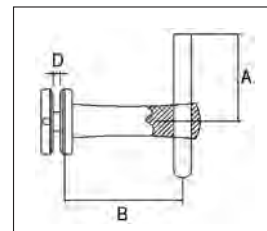

SA 423 (BF 00) BA AISI-316

| pcs/box | A | B | D |
|---------|--------|----|---------|
| 2 | 30-100 | 80 | 6-17,52 |

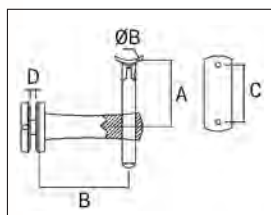

SA 423 (BG R) BA AISI-316

| pcs/box | ØB | A | B | C | D |
|---------|------|-------|----|------|---------|
| 2 | 43 | 30-70 | 80 | 51,5 | 6-17,52 |
| 2 | 50,8 | 30-70 | 80 | 61,5 | 6-17,52 |

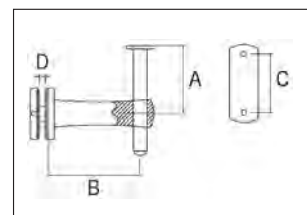

SA 423 (BF R) BA AISI-316

| pcs/box | ØB | A | B | C | D |
|---------|------|-------|----|------|---------|
| 2 | 43 | 30-70 | 80 | 51,5 | 6-17,52 |
| 2 | 50,8 | 30-70 | 80 | 61,5 | 6-17,52 |

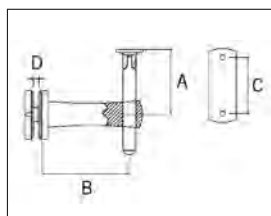

SA 423 (BG FLAT) BA AISI-316

| pcs/box | A | B | C | D |
|---------|-------|----|------|---------|
| 2 | 30-70 | 80 | 51,5 | 6-17,52 |

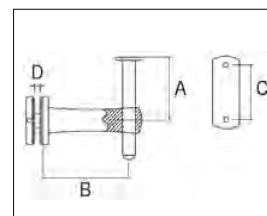

SA 423 (BF FLAT) BA AISI-316

| pcs/box | A | B | C | D |
|---------|-------|----|------|---------|
| 2 | 30-70 | 80 | 51,5 | 6-17,52 |

Codos y soportes tubo

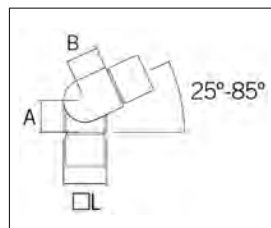

SA 433 BA AISI-316

| pcs/box | □L | A | B | E* |
|---------|-------|----|----|-----|
| 2 | 40x40 | 30 | 30 | 1,5 |

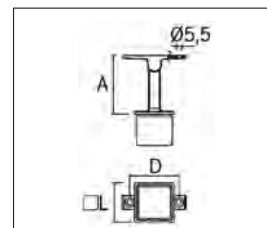

SA 434 AISI-316

| pcs/box | □L | A | D | E* |
|---------|-------|----|----|-----|
| 2 | 40x40 | 60 | 50 | 1,5 |

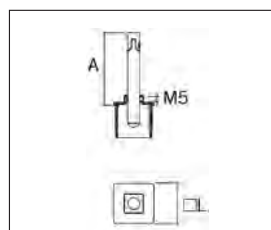
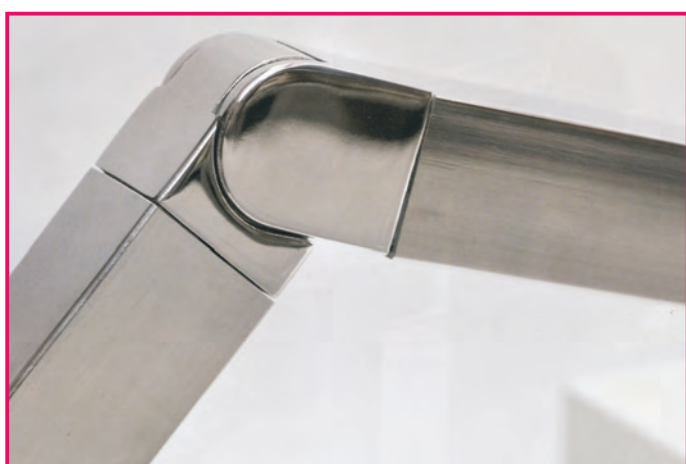

SA 440 (BG 00) BA AISI-316

| pcs/box | □L | A | E* |
|---------|-------|--------|-----|
| 2 | 40x40 | 30-100 | 1,5 |
| 2 | 50x50 | 30-100 | 1,5 |

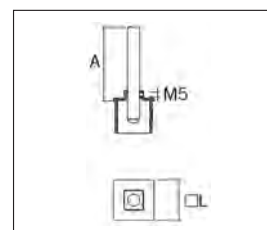

SA 440 (BF 00) BA AISI-316

| pcs/box | □L | A | E* |
|---------|-------|--------|-----|
| 2 | 40x40 | 30-100 | 1,5 |
| 2 | 50x50 | 30-100 | 1,5 |

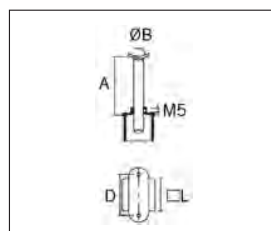

SA 440 (BG R) BA AISI-316

| pcs/box | ØB | □L | A | D | E* |
|---------|------|-------|--------|------|-----|
| 2 | 43 | 40x40 | 30-100 | 51,5 | 1,5 |
| 2 | 50,8 | 40x40 | 30-100 | 61,5 | 1,5 |
| 2 | 43 | 50x50 | 30-100 | 51,5 | 1,5 |
| 2 | 50,8 | 50x50 | 30-100 | 61,5 | 1,5 |

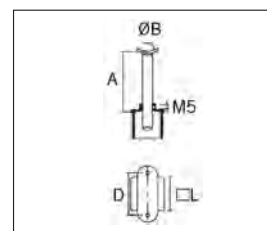

SA 440 (BF R) BA AISI-316

| pcs/box | ØB | □L | A | D | E* |
|---------|------|-------|--------|------|-----|
| 2 | 43 | 40x40 | 30-100 | 51,5 | 1,5 |
| 2 | 50,8 | 40x40 | 30-100 | 61,5 | 1,5 |
| 2 | 43 | 50x50 | 30-100 | 51,5 | 1,5 |
| 2 | 50,8 | 50x50 | 30-100 | 61,5 | 1,5 |

Soportes tubo

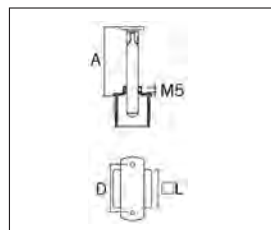

SA 440 (BG FLAT) BA AISI-316

| pcs/box | □L | A | D | E* |
|---------|-------|--------|------|-----|
| 2 | 40x40 | 30-100 | 51,5 | 1,5 |
| 2 | 50x50 | 30-100 | 51,5 | 1,5 |

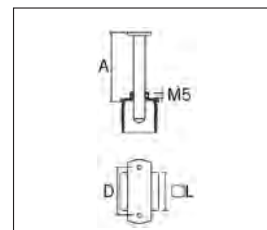

SA 440 (BF FLAT) BA AISI-316

| pcs/box | □L | A | D | E* |
|---------|-------|--------|------|-----|
| 2 | 40x40 | 30-100 | 51,5 | 1,5 |
| 2 | 50x50 | 30-100 | 51,5 | 1,5 |

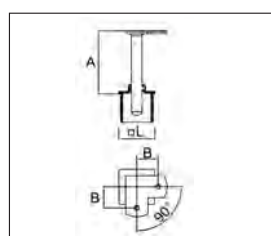

SA 440 (BFC FLAT 90) BA AISI-316

| pcs/box | □L | A | B | E* |
|---------|-------|--------|----|-----|
| 2 | 40x40 | 30-100 | 24 | 1,5 |
| 2 | 50x50 | 30-100 | 24 | 1,5 |

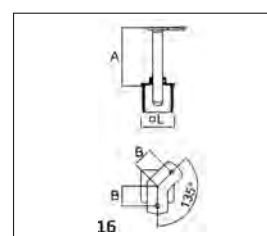

SA 440 (BFC FLAT 135) BA AISI-316

| pcs/box | □L | A | B | E* |
|---------|-------|--------|----|-----|
| 2 | 40x40 | 30-100 | 24 | 1,5 |
| 2 | 50x50 | 30-100 | 24 | 1,5 |

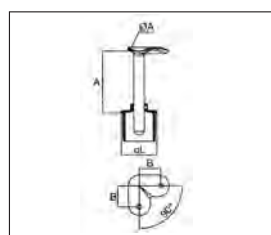

SA 440 (BFC-R 90) BA AISI-316

| pcs/box | □L | ØA | A | B | E* |
|---------|-------|------|--------|----|-----|
| 2 | 40x40 | 43 | 30-100 | 24 | 1,5 |
| 2 | 40x40 | 50,8 | 30-100 | 24 | 1,5 |
| 2 | 50x50 | 43 | 30-100 | 24 | 1,5 |
| 2 | 50x50 | 50,8 | 30-100 | 24 | 1,5 |

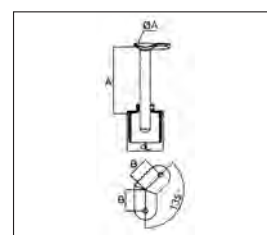

SA 440 (BFC-R 135) BA AISI-316

| pcs/box | □L | ØA | A | B | E* |
|---------|-------|------|--------|----|-----|
| 2 | 40x40 | 43 | 30-100 | 24 | 1,5 |
| 2 | 40x40 | 50,8 | 30-100 | 24 | 1,5 |
| 2 | 50x50 | 43 | 30-100 | 24 | 1,5 |
| 2 | 50x50 | 50,8 | 30-100 | 24 | 1,5 |

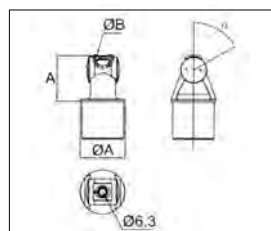

SA 450 BA AISI-316

| pcs/box | ØA | ØB | A | α |
|---------|------|------|----|-----|
| 2 | 38,1 | 38,1 | 44 | 60° |
| 2 | 38,1 | 50,8 | 44 | 60° |
| 2 | 43 | 43 | 44 | 60° |
| 2 | 50,8 | 38,1 | 44 | 60 |
| 2 | 50,8 | 50,8 | 44 | 60° |

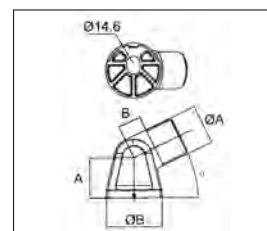

SA 451 BA AISI-316

| pcs/box | ØA | ØB | A | B | α |
|---------|------|----|------|----|-------|
| 2 | 38,1 | 60 | 43,5 | 25 | 26-90 |
| 2 | 43 | 60 | 43,5 | 25 | 26-90 |
| 2 | 50,8 | 60 | 43,5 | 25 | 26-90 |

Barras y adaptadores tubo

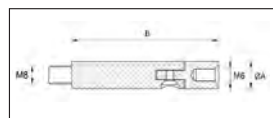

SA 480 BA AISI-316

| pcs/box | ØA | B |
|---------|----|----|
| 2 | 12 | 65 |

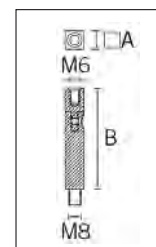

SA 481 BA AISI-316

| pcs/box | □A | B |
|---------|----|----|
| 2 | 12 | 65 |

Codos y conectores de tubo

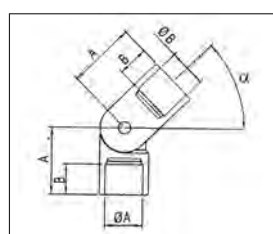

SA 486 BA AISI-316

| pcs/box | ØA | ØB | A | B | α |
|---------|----|----|----|----|------|
| 2 | 12 | 12 | 22 | 10 | 0-90 |



Tapones y remates finales

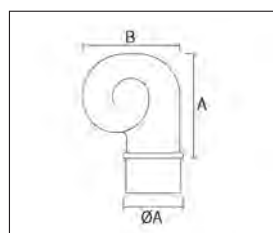

TF 500 BA AISI-316

| pcs/box | ØA | A | B | E* |
|---------|------|----|----|-----|
| 5 | 43 | 70 | 74 | 1,5 |
| 10 | 50,8 | 80 | 74 | 1,5 |

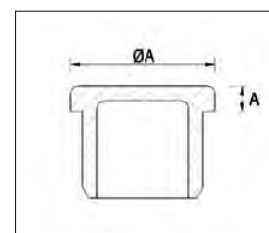

TF 502 BA AISI-316

| pcs/box | ØA | A | E* |
|---------|------|---|-----|
| 4 | 12 | 2 | 1 |
| 4 | 14 | 2 | 1,5 |
| 4 | 15 | 2 | 1,5 |
| 4 | 16 | 2 | 1,5 |
| 4 | 18 | 2 | 1,5 |
| 4 | 20 | 2 | 1,5 |
| 4 | 25 | 2 | 1,5 |
| 2 | 30 | 2 | 1,5 |
| 2 | 33 | 2 | 1,5 |
| 2 | 38,1 | 2 | 1,5 |
| 2 | 40 | 2 | 1,5 |
| 2 | 43 | 2 | 1,5 |
| 2 | 50,8 | 2 | 1,5 |
| 2 | 63,5 | 2 | 1,5 |

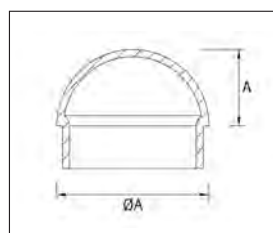

TF 501 BA AISI-316

| pcs/box | ØA | A | E* |
|---------|------|------|-----|
| 2 | 38,1 | 19,5 | 1,5 |
| 2 | 43 | 21,5 | 1,5 |
| 2 | 50,8 | 25 | 1,5 |

Tapones y remates finales

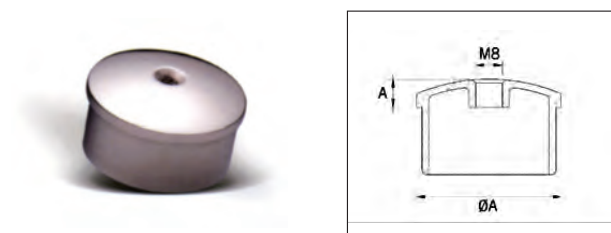

TF 503 BA AISI-316

| pcs/box | ØA | A | E* |
|---------|------|-----|-----|
| 2 | 43 | 8,4 | 1,5 |
| 2 | 50,8 | 8,4 | 1,5 |



TF 504 BA AISI-316

| pcs/box | ØA |
|---------|----|
| 2 | 50 |
| 2 | 70 |

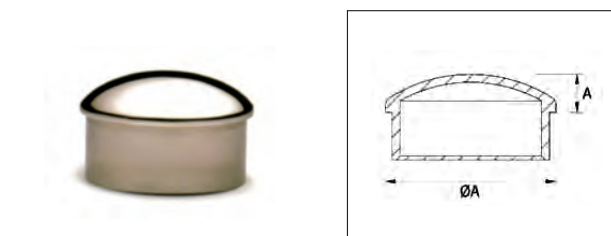

TF 505 BA AISI-316

| pcs/box | ØA | A | E* |
|---------|------|-----|-----|
| 2 | 38,1 | 8 | 1,5 |
| 2 | 43 | 9,5 | 1,5 |
| 2 | 50,8 | 12 | 1,5 |

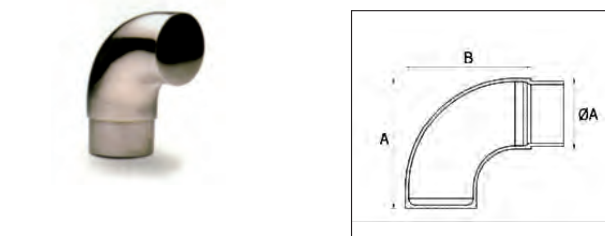

TF 506 BA AISI-316

| pcs/box | ØA | A | B | E* |
|---------|------|----|----|-----|
| 2 | 50,8 | 83 | 80 | 1,5 |

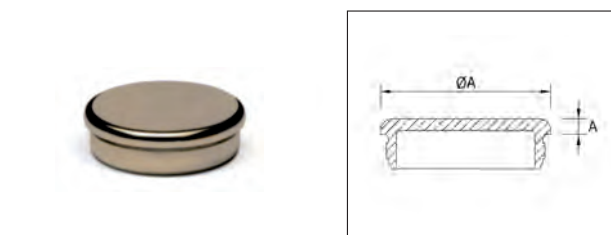

TF 507 BA AISI-316

| pcs/box | ØA | A | E* |
|---------|------|---|-----|
| 2 | 43 | 4 | 1,5 |
| 2 | 50,8 | 4 | 1,5 |



TF 508 BA AISI-316

| pcs/box | ØA | A | E* |
|---------|----|----|----|
| 4 | 12 | 14 | 1 |

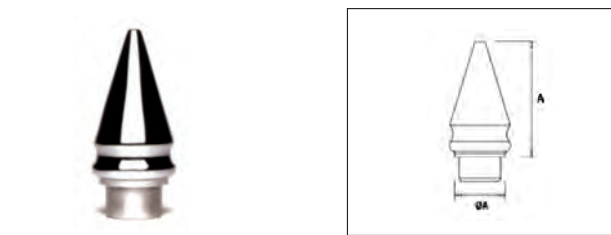

TF 509 BA AISI-316

| pcs/box | ØA | A | E* |
|---------|----|----|-----|
| 4 | 20 | 46 | 1,5 |



TF 510 BA AISI-316

| pcs/box | ØA | A | ØB |
|---------|----|---|----|
| 4 | 12 | 6 | 15 |

Tapones y remates finales

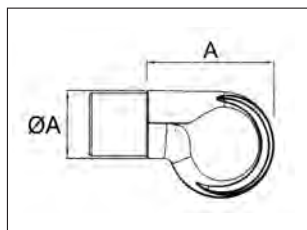

TF 511 BA AISI-316

| pcs/box | ØA | A |
|---------|----|----|
| 2 | 43 | 81 |

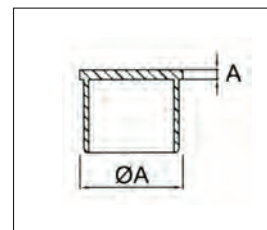

TF 512 BA AISI-316

| pcs/box | ØA | A |
|---------|------|----|
| 2 | 42,4 | 81 |

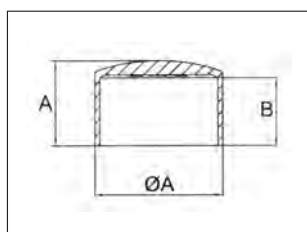

TF 513 BA AISI-316

| pcs/box | ØA | A | B |
|---------|----|----|----|
| 2 | 45 | 30 | 24 |

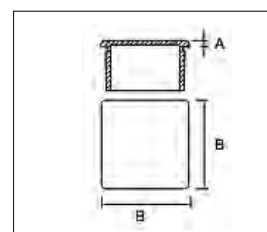

TF 530 BA AISI-316

| pcs/box | □L | A | E* |
|---------|-------|---|-----|
| 2 | 20x20 | 3 | 1,5 |
| 2 | 30x30 | 3 | 1,5 |
| 2 | 40x40 | 3 | 1,5 |
| 2 | 50x50 | 3 | 1,5 |

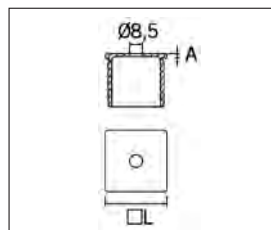

TF 533 BA AISI-316

| pcs/box | □L | A | E* |
|---------|-------|---|-----|
| 2 | 40x40 | 3 | 1,5 |

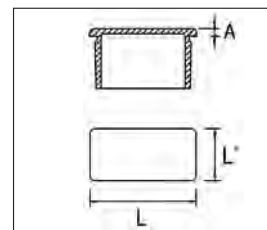

TF 535 BA AISI-316

| pcs/box | L | L' | A | E* |
|---------|----|----|---|-----|
| 4 | 20 | 10 | 3 | 1,5 |
| 2 | 40 | 20 | 3 | 1,5 |

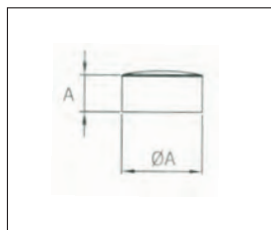

TF 590 BA AISI-316

| pcs/box | ØA | A | M |
|---------|------|----|----------------|
| 4 | 18 | 11 | MT MB / CH M6 |
| 4 | 21,5 | 12 | MT M10 / CH MB |

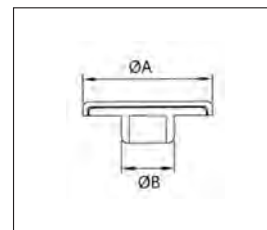

TF 595 BA AISI-316

| pcs/box | ØA | A | M |
|---------|----|---|---|
| 4 | 13 | 5 | |

Macollas

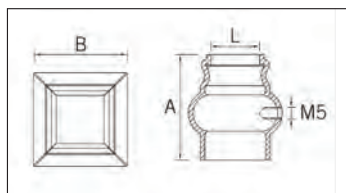

MC 900 BA AISI-316

| pcs/box | □L | A | B |
|---------|-------|----|----|
| 4 | 20x20 | 45 | 40 |

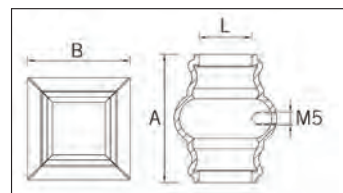

MC 910 BA AISI-316

| pcs/box | □L | A | B |
|---------|-------|----|----|
| 4 | 20x20 | 50 | 40 |

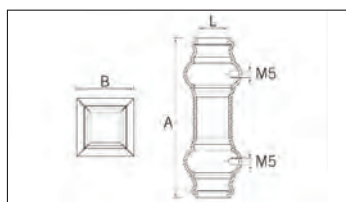

MC 911 BA AISI-316

| pcs/box | □L | A | B |
|---------|-------|-----|----|
| 2 | 20x20 | 110 | 40 |

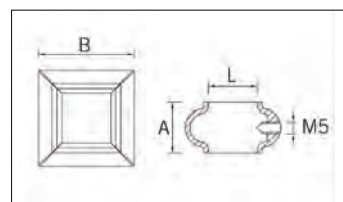

MC 912 BA AISI-316

| pcs/box | □L | A | B |
|---------|-------|----|----|
| 4 | 20x20 | 21 | 40 |

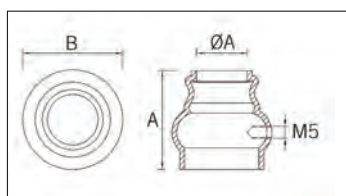

MC 950 BA AISI-316

| pcs/box | ØA | A | B |
|---------|----|----|----|
| 4 | 20 | 40 | 40 |

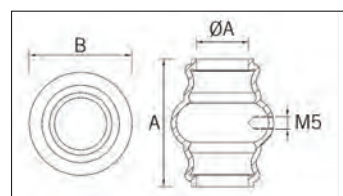

MC 960 BA AISI-316

| pcs/box | ØA | A | B |
|---------|----|----|----|
| 4 | 20 | 50 | 40 |

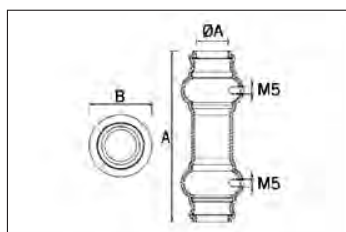

MC 961 BA AISI-316

| pcs/box | ØA | A | B |
|---------|----|-----|----|
| 2 | 20 | 110 | 40 |

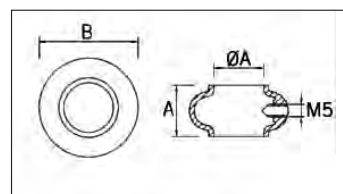

MC 962 BA AISI-316

| pcs/box | ØA | A | B |
|---------|----|----|------|
| 4 | 20 | 21 | 40,5 |

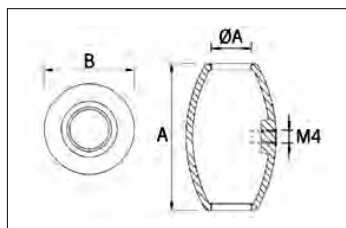

MC 963 BA AISI-316

| pcs/box | ØA | A | B |
|---------|----|----|----|
| 4 | 12 | 45 | 28 |



MC 961

Accesorios para cable inox

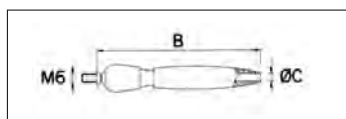

SC 800 BA AISI-316

| pcs/box | ØC | B |
|---------|--------|-----|
| 2 | 4-5 mm | 112 |

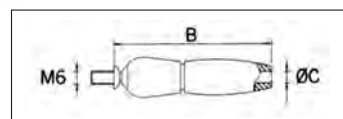

SC 801 BA AISI-316

| pcs/box | ØC | B |
|---------|--------|----|
| 2 | 4-5 mm | 71 |

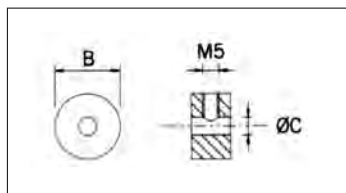

SC 850 BA AISI-316

| pcs/box | ØC | B |
|---------|--------|----|
| 4 | 4-5 mm | 20 |

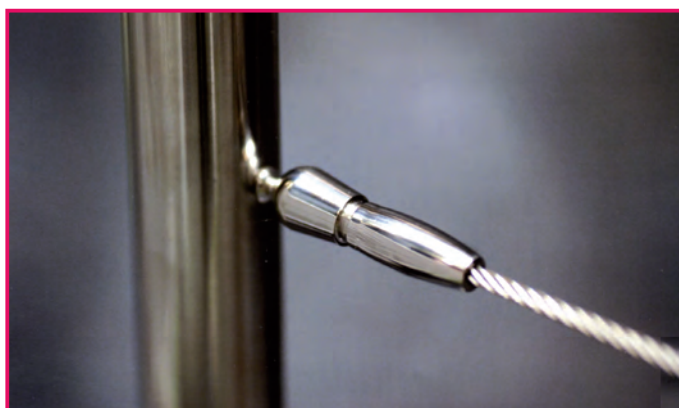

Accesorios

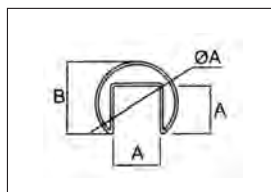

RP-1400 BA AISI-316

| LG | ØA | A | B | E* |
|------|------|----|----|-----|
| 5000 | 42,4 | 24 | 37 | 1,5 |

TR BA AISI-316

CABLE Ø 3 - 4 - 5 - 6 - 8 mm

SENSOR - MONTAJE RÁPIDO

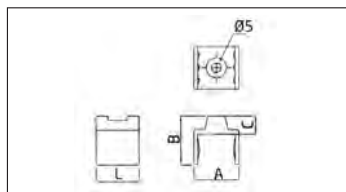
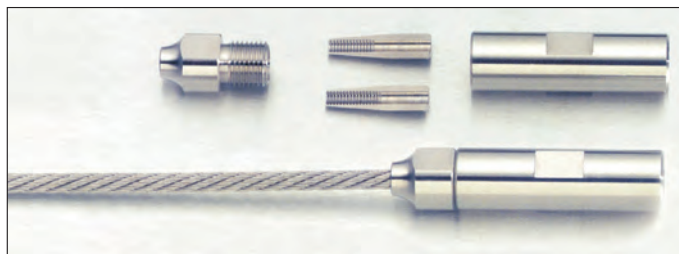

AL-00 BA AISI-316

| pcs/box | A | B | C | L |
|---------|----|----|---|----|
| 10 | 21 | 23 | 9 | 20 |

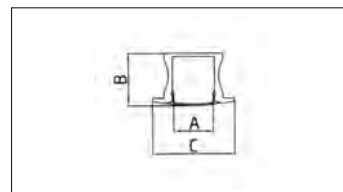

AL-01 BA AISI-316

| LG | A | B | C |
|------|----|----|----|
| 2000 | 12 | 16 | 24 |

Perfil pasamanos en U

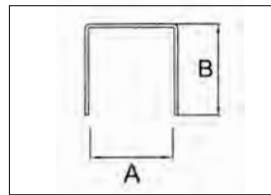

| LG | A | B | E* |
|------|-------------|----|-----|
| 2500 | 12-12,76 | 15 | 1,5 |
| 2500 | 16,38-17,52 | 20 | 1,5 |
| 2500 | 20,38-21-52 | 20 | 1,5 |

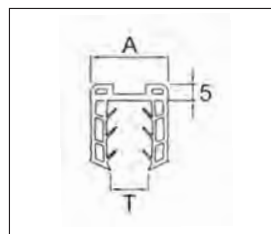

PL-03

| LG | A | T |
|------|----|-------------|
| 5000 | 24 | 8-11,52 |
| 5000 | 24 | 12-13,52 |
| 5000 | 24 | 15 |
| 5000 | 24 | 16,38-17,52 |
| 5000 | 24 | 20,38-21,52 |

Tubo y accesorios en U

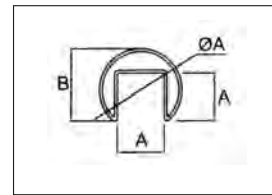

RP-1400 BA AISI-304

| LG | ØA | A | B | E* |
|------|------|----|----|-----|
| 5000 | 42,4 | 24 | 37 | 1,5 |

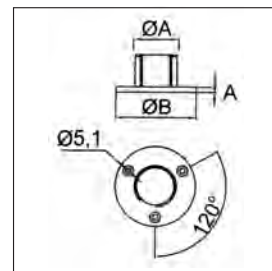

AV-609 BA AISI-316

| pcs/box | ØA | ØB | A | E* |
|---------|------|----|---|-----|
| 2 | 42,4 | 75 | 5 | 1,5 |

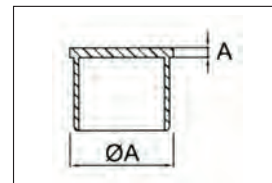

TF 512 BA AISI-316

| pcs/box | ØA | A | E* |
|---------|------|---|-----|
| 2 | 42,4 | 4 | 1,5 |



Perfil montaje superior 1,6 kN

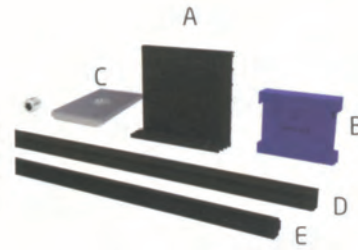
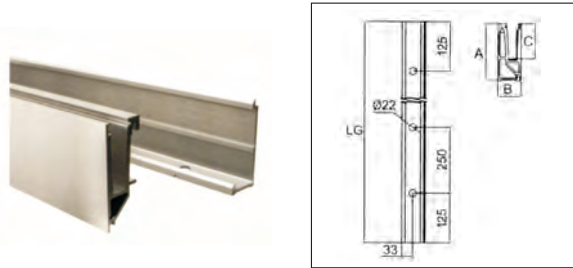

SV-1200-1 ALUMINIO ANODIZADO

| pcs/box | LG | A | B | C |
|---------|------|-----|----|-----|
| 1 | 2500 | 172 | 70 | 100 |

PL-10

| G | A/Pcs | B/Pcs | C/Pcs | D (LG) | E (LG) | F/Pcs |
|-------------|-------|-------|-------|--------|--------|-------|
| 12-12,38 | 10 | 10 | 10 | 2500 | 2500 | 10 |
| 12,76 | 10 | 10 | 10 | 2500 | 2500 | 10 |
| 13,52 | 10 | 10 | 10 | 2500 | 2500 | 10 |
| 15 | 10 | 10 | 10 | 2500 | 2500 | 10 |
| 16,38-16,76 | 10 | 10 | 10 | 2500 | 2500 | 10 |
| 17,52 | 10 | 10 | 10 | 2500 | 2500 | 10 |
| 20,38-20,76 | 10 | 10 | 10 | 2500 | 2500 | 10 |
| 21,52 | 10 | 10 | 10 | 2500 | 2500 | 10 |

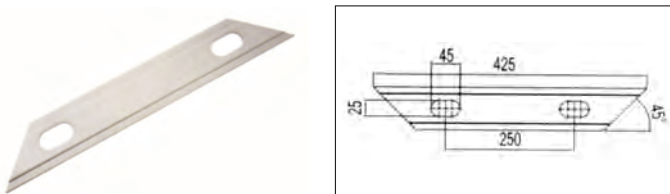

PM 23 ALUMINIO ANONIZADO

| pcs/box |
|---------|
| 5 |



Perfil montaje superior 1,6 kN

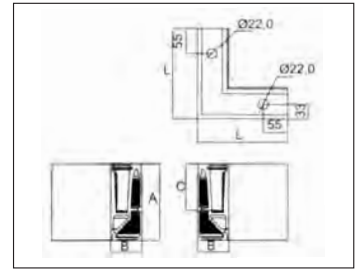
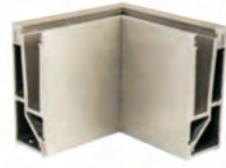
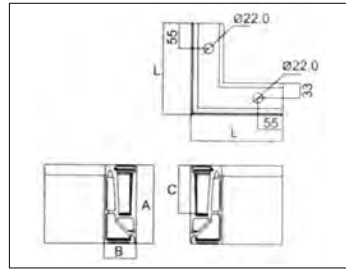
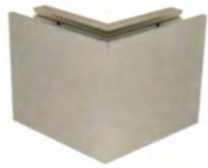

SV-1200-1C ALUMINIO ANONIZADO

| pcs/box | L | A | B | C |
|---------|-----|-----|----|-----|
| 1 | 200 | 172 | 70 | 100 |

SV-1200-1C ALUMINIO ANONIZADO

| pcs/box | L | A | B | C |
|---------|-----|-----|----|-----|
| 1 | 200 | 172 | 70 | 100 |

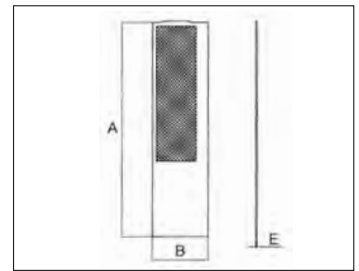
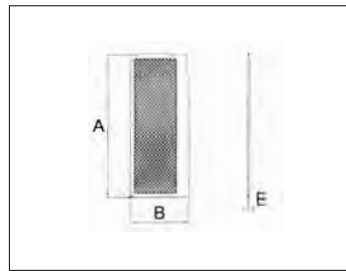

PM 21 ALUMINIO ANONIZADO

| pcs/box | A | B | E | L/R |
|---------|-----|----|---|-----|
| 1 | 172 | 70 | 2 | L/R |

PM 22 ALUMINIO ANONIZADO

| pcs/box | A | B | E | L/R |
|---------|-----|----|---|-----|
| 1 | 270 | 70 | 2 | L/R |

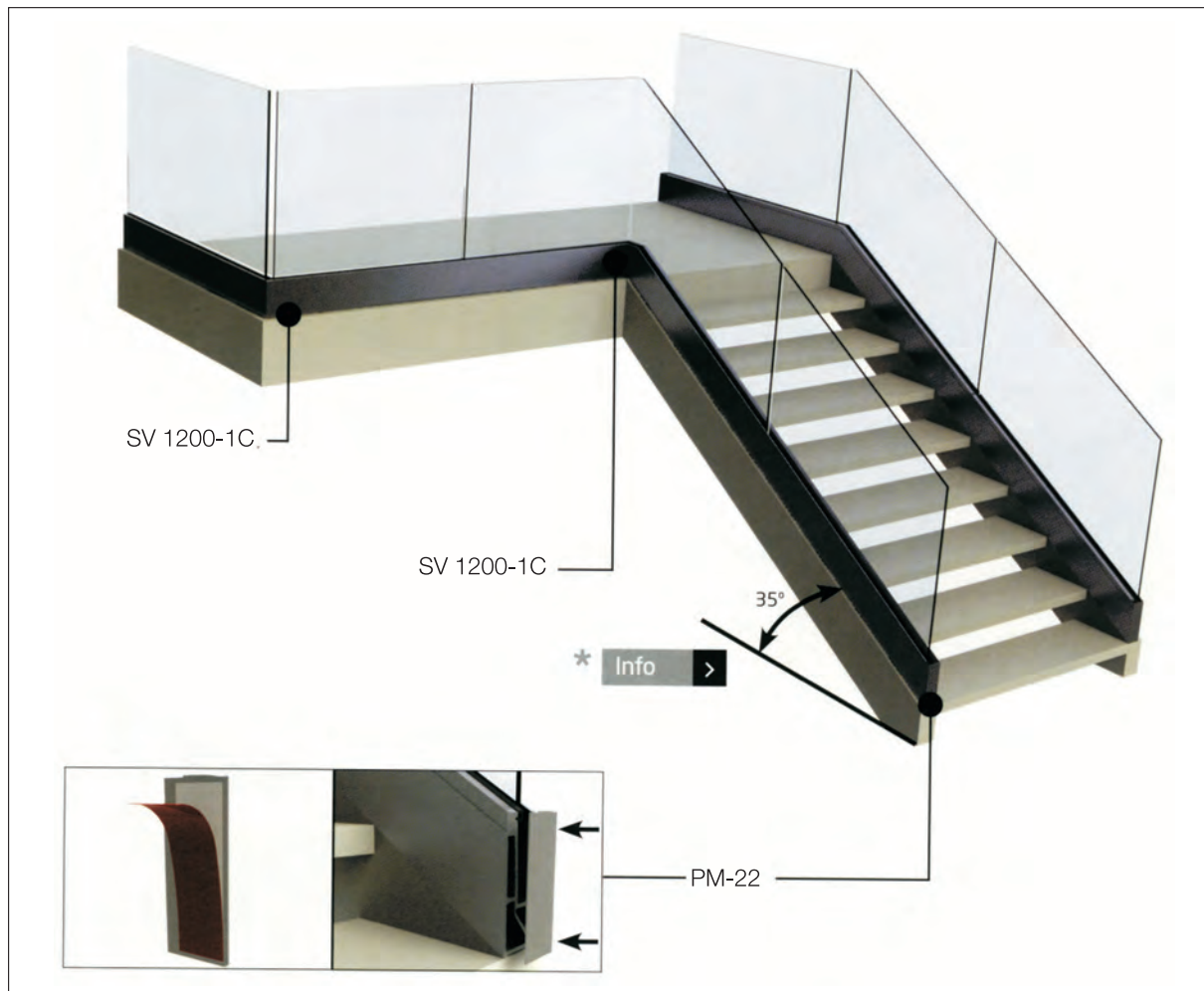

Perfil montaje superior 1,6 kN

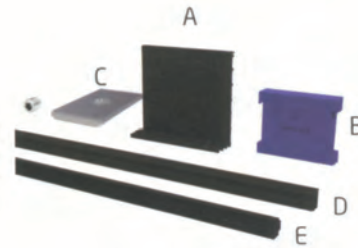
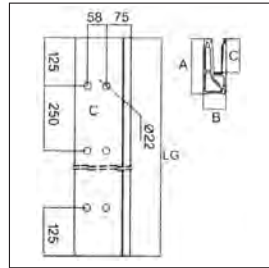

SV-1200-2 ALUMINIO ANODIZADO

| pcs/box | LG | A | B | C |
|---------|------|-----|----|-----|
| 1 | 2500 | 172 | 70 | 100 |

PL-10

| G | A/Pcs | B/Pcs | C/Pcs | D (LG) | E (LG) | F/Pcs |
|-------------|-------|-------|-------|--------|--------|-------|
| 12-12,38 | 10 | 10 | 10 | 2500 | 2500 | 10 |
| 12,76 | 10 | 10 | 10 | 2500 | 2500 | 10 |
| 13,52 | 10 | 10 | 10 | 2500 | 2500 | 10 |
| 15 | 10 | 10 | 10 | 2500 | 2500 | 10 |
| 16,38-16,76 | 10 | 10 | 10 | 2500 | 2500 | 10 |
| 17,52 | 10 | 10 | 10 | 2500 | 2500 | 10 |
| 20,38-20,76 | 10 | 10 | 10 | 2500 | 2500 | 10 |
| 21,52 | 10 | 10 | 10 | 2500 | 2500 | 10 |

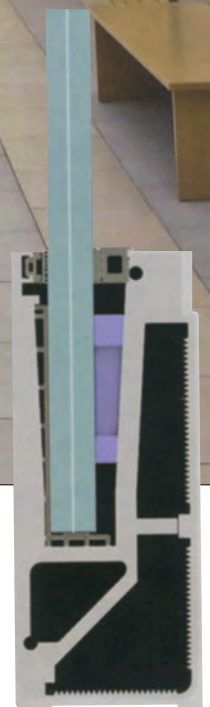

Perfil montaje superior 1 kN

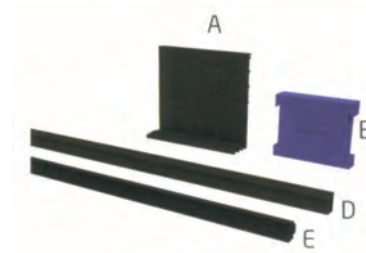
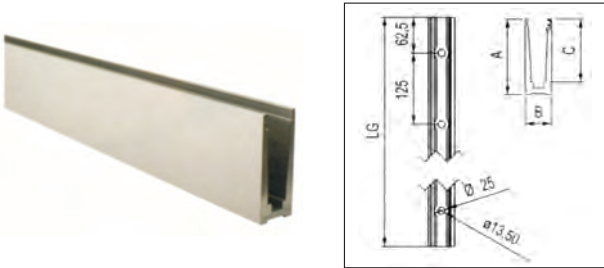

| SV-1301-1-1 ALUMINIO ANODIZADO | | | | |
|--------------------------------|------|-----|----|-----|
| pcs/box | LG | A | B | C |
| 1 | 2500 | 132 | 46 | 110 |
| 1 | 5000 | 132 | 46 | 110 |

| PL-11 | | | | |
|-------------|-------|-------|--------|--------|
| G | A/Pcs | B/Pcs | D (LG) | E (LG) |
| 12-12,38 | 10 | 10 | 2500 | 2500 |
| 12,76 | 10 | 10 | 2500 | 2500 |
| 13,52 | 10 | 10 | 2500 | 2500 |
| 15 | 10 | 10 | 2500 | 2500 |
| 16,38-16,76 | 10 | 10 | 2500 | 2500 |
| 17,52 | 10 | 10 | 2500 | 2500 |
| 20,38-20,76 | 10 | 10 | 2500 | 2500 |
| 21,52 | 10 | 10 | 2500 | 2500 |



Perfil montaje superior 1 kN

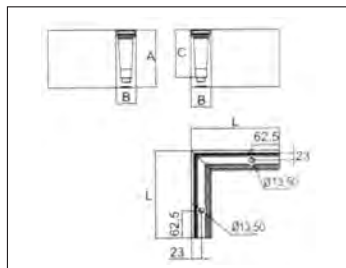
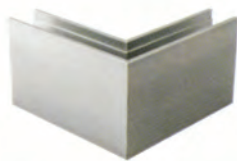

SV-1301-1-1C ALUMINIO ANONIZADO

| pcs/box | L | A | B | C |
|---------|-----|-----|----|-----|
| 1 | 200 | 132 | 46 | 110 |

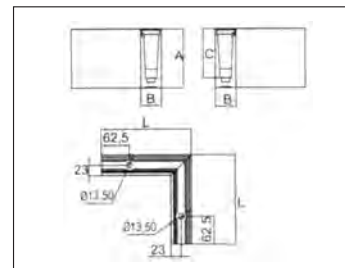

SV-1301-1-1C ALUMINIO ANONIZADO

| pcs/box | L | A | B | C |
|---------|-----|-----|----|-----|
| 1 | 200 | 132 | 46 | 110 |

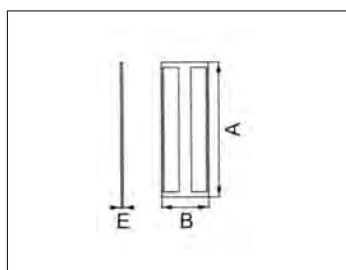

PM 24 ALUMINIO ANONIZADO

| pcs/box | A | B | E |
|---------|-----|----|---|
| 1 | 132 | 46 | 2 |

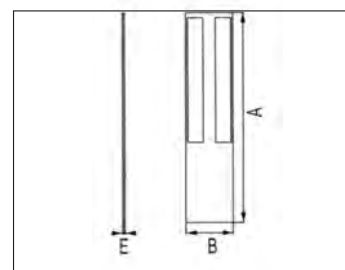

PM 25 ALUMINIO ANONIZADO

| pcs/box | A | B | E |
|---------|-----|----|---|
| 1 | 206 | 46 | 2 |

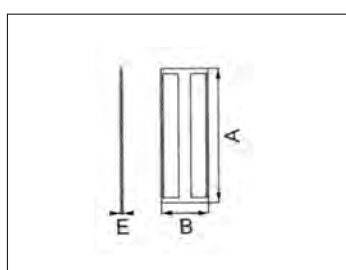

PM 27 ALUMINIO ANONIZADO

| pcs/box | A | B | E |
|---------|-----|----|---|
| 1 | 132 | 52 | 2 |

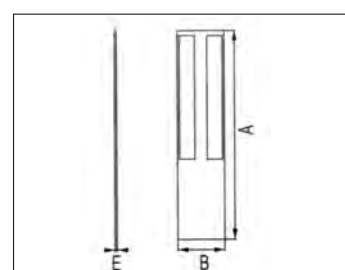

PM 28 ALUMINIO ANONIZADO

| pcs/box | A | B | E |
|---------|-----|----|---|
| 1 | 210 | 52 | 2 |

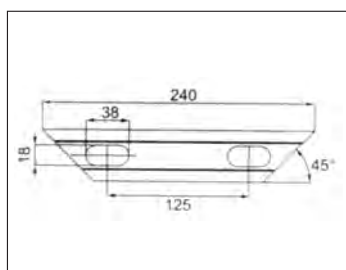

PM 26 ALUMINIO ANONIZADO

| pcs/box |
|---------|
| 10 |

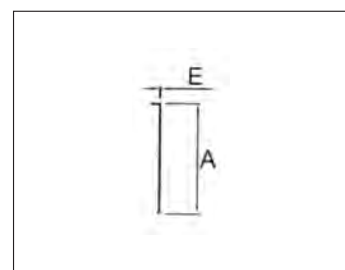

PM 50 ALUMINIO ANONIZADO

| pcs/box | L | A | E | INT/OUT |
|---------|------|-----|---|---------|
| 2 | 2500 | 133 | 1 | IN |
| 2 | 2500 | 133 | 1 | OUT |

Perfil montaje superior 1 kN

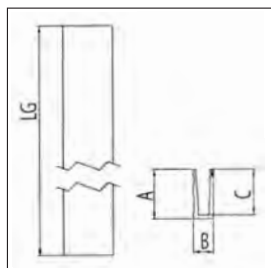

SV-1303 ALUMINIO CRUDO

| pcs/box | LG | A | B | C |
|---------|------|-----|----|-----|
| 1 | 2500 | 132 | 46 | 110 |
| 1 | 5000 | 132 | 46 | 110 |

Perfil montaje lateral 1 kN

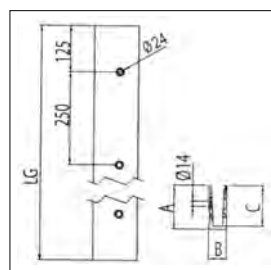

SV-1302-2-1 ALUMINIO ANONIZADO

| pcs/box | LG | A | B | C |
|---------|------|-----|----|-----|
| 1 | 2500 | 119 | 49 | 110 |
| 1 | 5000 | 119 | 49 | 110 |

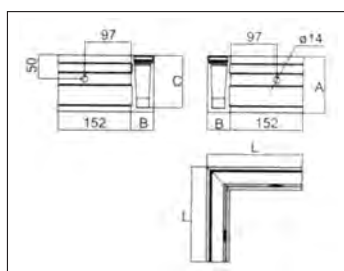
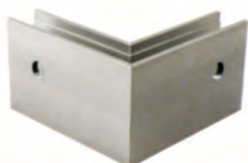

SV-1302-2-1C ALUMINIO ANONIZADO

| pcs/box | L | A | B | C |
|---------|-----|-----|----|-----|
| 1 | 200 | 119 | 48 | 110 |

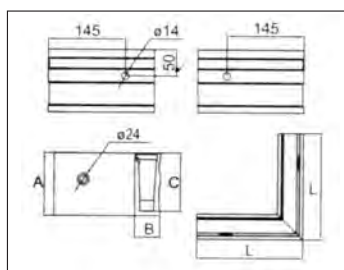

SV-1302-2-1C ALUMINIO ANONIZADO

| pcs/box | L | A | B | C |
|---------|-----|-----|----|-----|
| 1 | 200 | 119 | 48 | 110 |

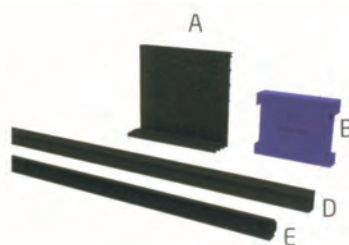

PL-11

| G | A/Pcs | B/Pcs | D (LG) | E (LG) |
|-------------|-------|-------|--------|--------|
| 12-12,38 | 10 | 10 | 2500 | 2500 |
| 12,76 | 10 | 10 | 2500 | 2500 |
| 13,52 | 10 | 10 | 2500 | 2500 |
| 15 | 10 | 10 | 2500 | 2500 |
| 16,38-16,76 | 10 | 10 | 2500 | 2500 |
| 17,52 | 10 | 10 | 2500 | 2500 |
| 20,38-20,76 | 10 | 10 | 2500 | 2500 |
| 21,52 | 10 | 10 | 2500 | 2500 |



Perfil montaje lateral 1 kN

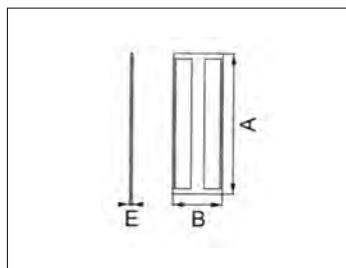

PM 29 ALUMINIO ANONIZADO

| pcs/box | A | B | E |
|---------|-----|----|---|
| 1 | 124 | 51 | 2 |

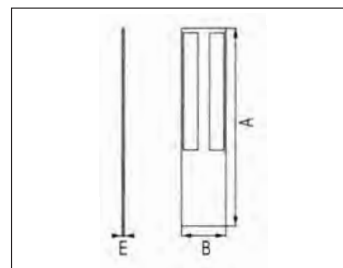

PM 30 ALUMINIO ANONIZADO

| pcs/box | A | B | E |
|---------|-----|----|---|
| 1 | 196 | 51 | 2 |

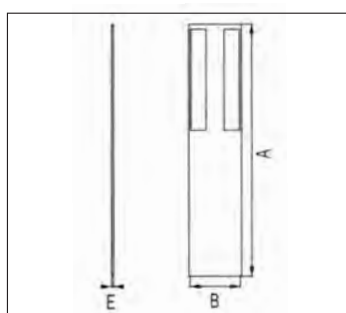

PM 31 ALUMINIO ANONIZADO

| pcs/box | A | B | E |
|---------|-----|------|---|
| 1 | 298 | 51,5 | 2 |

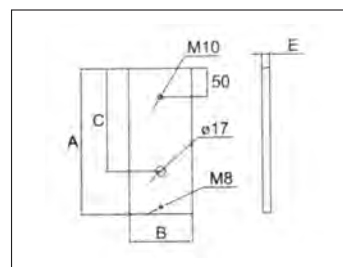

PM 60 ZINC PLATEADO

| pcs/box | A | B | C | E |
|---------|-----|-----|-----|----|
| 1 | 255 | 110 | 180 | 14 |

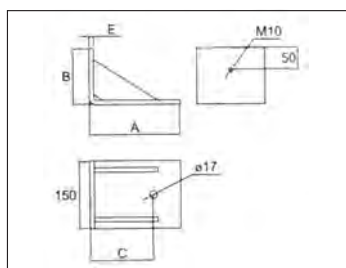
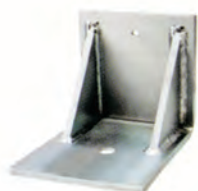

PM 61 ZINC PLATEADO

| pcs/box | A | B | C | E |
|---------|-----|-----|-----|----|
| 1 | 200 | 125 | 140 | 10 |
| 1 | 200 | 150 | 140 | 10 |

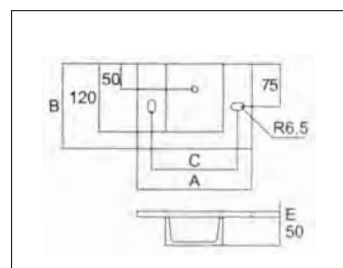

PM 62 ZINC PLATEADO

| pcs/box | A | B | C | E |
|---------|-----|-----|-----|----|
| 1 | 200 | 150 | 150 | 10 |

Instalación

PM 60

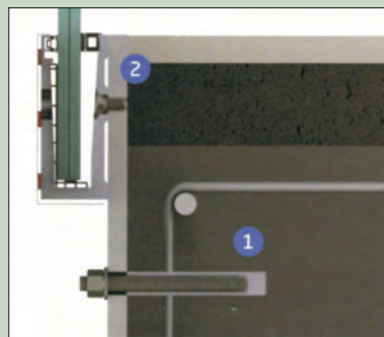

1 FIS SB 390 S M12
2 DIN 7991 M10

PM 61

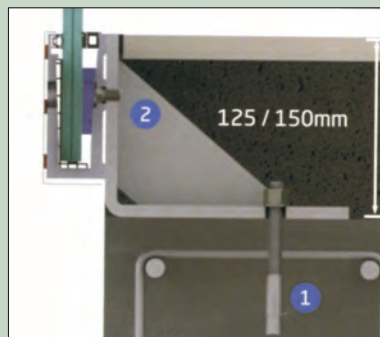

1 FAZ II M12
2 DIN 7991 M10

PM 62

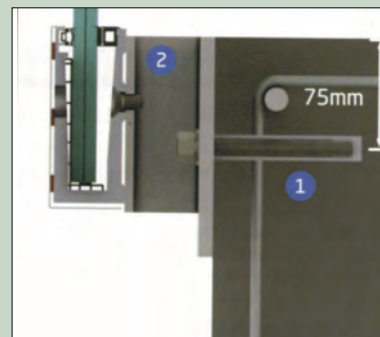

1 FIS SB 390 S M12
2 DIN 7991 M10